

### Ultrasonic Anemometer

(Part 1951-PK-020)

Doc No: 1951-PS-001

Issue 3

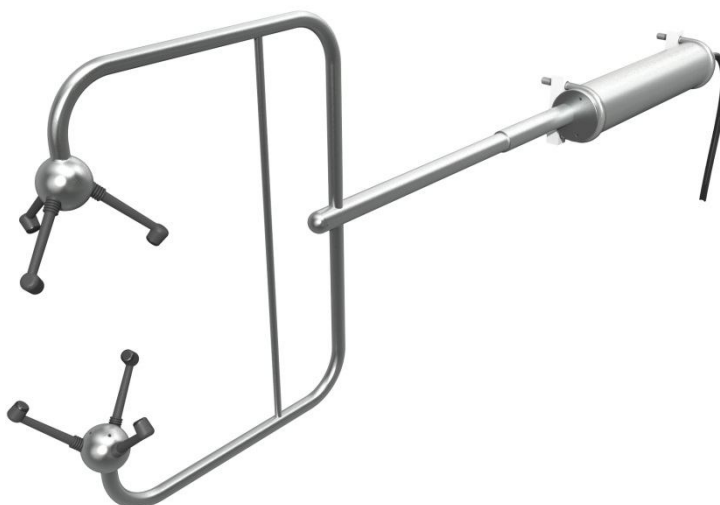

Gill Instruments Limited  
Saltmarsh Park, 67 Gosport Street, Lymington,  
Hampshire, SO41 9EG, UK  
Tel: +44 1590 613500, Fax: +44 1590 613555  
Email: [anem@gillinstruments.com](mailto:anem@gillinstruments.com) Website: [www.gillinstruments.com](http://www.gillinstruments.com)

# Contents

## Contents 2

|  |           |
|--|-----------|
| <b>1. FOREWORD</b>   | <b>4</b>  |
| <b>2. INTRODUCTION</b>   | <b>4</b>  |
| <b>3. PRINCIPLE OF OPERATION</b>   | <b>5</b>  |
| Polar definition   | 6         |
| U, V, and W axes definition  | 6         |
| Effects of temperature, barometric pressure, rainfall and humidity                           | 7         |
| Measurement sequence   | 7         |
| Signal processing  | 7         |
| <b>4. SPECIFICATION</b>  | <b>8</b>  |
| <b>5. PRE-INSTALLATION</b>   | <b>9</b>  |
| <b>5.1. Equipment supplied</b>   | <b>9</b>  |
| <b>5.2. Software</b>   | <b>9</b>  |
| <b>5.3. Options</b>  | <b>9</b>  |
| <b>5.4. Accessories</b>  | <b>9</b>  |
| <b>5.5. Packaging</b>  | <b>9</b>  |
| <b>5.6. Installation requirements</b>  | <b>9</b>  |
| PC requirement   | 9         |
| Other equipment  | 9         |
| Connection   | 10        |
| Power supply   | 10        |
| <b>6. INSTALLATION</b>   | <b>11</b> |
| <b>6.1. Installation Guidelines</b>  | <b>11</b> |
| <b>6.2. Bench system test</b>  | <b>11</b> |
| <b>6.3. Cable type</b>   | <b>12</b> |
| <b>6.4. Cable length</b>   | <b>12</b> |
| Grounding (Earthing)   | 12        |
| Optional WindMaster HS Cable Interface box (Part 1951-PK-021)                                | 13        |
| <b>6.5. Connections</b>  | <b>14</b> |
| <b>6.6. Connection to a PC using RS 232</b>  | <b>15</b> |
| <b>6.7. Connection to a PC using RS 422</b>  | <b>15</b> |
| <b>6.8. RS422 Connection to a PC via a Power and Communications Interface (1189-PK-021).</b> | <b>16</b> |
| Environmental  | 16        |
| PCI Electrical Power Requirements  | 16        |
| PCI Operation.   | 16        |
| Connector Pin and Cable Assignments for PCI  | 17        |
| PCIA Box (1189-PK-020) WindMaster HS Analogue Output Connections.                            | 17        |
| <b>6.9. Using RS485 2 Wire Point to Point only</b>   | <b>19</b> |
| <b>6.10. Mechanical installation</b>   | <b>20</b> |
| Location   | 20        |
| Corrosion  | 20        |
| Sealing  | 20        |
| Mounting and Alignment   | 20        |
| Grounding (Earthing) See previous illustration   | 21        |
| Cable strain relief  | 21        |
| WindMaster HS Dimensions   | 21        |
| <b>7. MESSAGE FORMATS</b>  | <b>22</b> |
| <b>7.1. Mode 1– ASCII, UVW, Continuous</b>   | <b>22</b> |
| WindMaster HS Identification node address  | 23        |
| Horizontal wind speed  | 23        |
| Vertical wind speed  | 23        |
| Units  | 23        |
| Speed of Sound (SOS)   | 23        |

|  |           |
|--|-----------|
| Sonic temperature  | 23        |
| Status   | 23        |
| Analogue Inputs (order option)   | 23        |
| Checksum   | 23        |
| Output rate (not displayed)  | 23        |
| <b>7.2. Mode 2 – ASCII, Polar, Continuous (Default)</b>                        | <b>24</b> |
| Horizontal wind direction  | 25        |
| <b>7.3. Mode 3–ASCII, UVW, Polled.</b>   | <b>25</b> |
| Polled Mode Notes General  | 26        |
| Syncpoll 0 Mode Notes (Default)  | 26        |
| Syncpoll 1 Mode Notes  | 26        |
| <b>7.4. Mode 4 –ASCII, Polar, Polled.</b>                                      | <b>27</b> |
| <b>7.5. Mode 7 –Binary, Polar, Short</b>                                       | <b>27</b> |
| <b>7.6. Mode 8 –Binary, UVW, Short</b>   | <b>27</b> |
| <b>7.7. Mode 9 –Binary, Polar, Long</b>  | <b>28</b> |
| <b>7.8. Mode 10 –Binary, UVW, Long</b>   | <b>28</b> |
| <b>8. ANALOGUE INPUTS</b>  | <b>29</b> |
| <b>8.1. Analogue Inputs</b>  | <b>29</b> |
| <b>8.2. Input Rates</b>  | <b>29</b> |
| <b>9. ANALOGUE OUTPUTS</b>   | <b>29</b> |
| <b>9.1. Output allocations</b>   | <b>29</b> |
| <b>9.2. Output types</b>   | <b>29</b> |
| <b>9.3. Voltage outputs</b>  | <b>29</b> |
| <b>9.4. Current outputs</b>  | <b>30</b> |
| Scaling  | 30        |
| <b>9.5. Polar wind direction wraparound</b>                                    | <b>31</b> |
| <b>9.6. Speed of Sound and Sonic Temperature</b>                               | <b>31</b> |
| <b>9.7. Status</b>   | <b>31</b> |
| <b>10. CONFIGURING</b>   | <b>32</b> |
| <b>10.1. WIND software</b>   | <b>32</b> |
| <b>10.2. Configuring using HyperTerminal</b>                                   | <b>36</b> |
| Setting up   | 36        |
| Entering Configuration mode  | 36        |
| Returning to Measurement mode  | 36        |
| Checking the configuration   | 36        |
| Changing settings  | 37        |
| Command List   | 37        |
| <b>10.3. Viewing and logging WindMaster Data using Gill WindView Software.</b> | <b>43</b> |
| <b>11. MAINTENANCE &amp; FAULT-FINDING</b>                                     | <b>46</b> |
| <b>11.1. Cleaning</b>  | <b>46</b> |
| <b>11.2. Servicing</b>   | <b>46</b> |
| <b>11.3. Fault-finding</b>   | <b>46</b> |
| <b>11.4. Status (error) codes</b>  | <b>46</b> |
| <b>11.5. Returning unit</b>  | <b>47</b> |
| <b>12. TESTS</b>   | <b>47</b> |
| <b>12.1. Bench test</b>  | <b>47</b> |
| <b>12.2. Calibration</b>   | <b>47</b> |
| Standard calibration   | 47        |
| Certified calibration  | 47        |
| <b>13. APPENDICES</b>  | <b>47</b> |
| <b>13.1. Guarantee</b>   | <b>47</b> |
| <b>13.2. Electrical Conformity</b>   | <b>48</b> |

## 1. FOREWORD

Thank you for purchasing a WindMaster HS manufactured by Gill Instruments Ltd. The unit has no customer serviceable parts and require no calibration or maintenance. To achieve optimum performance we recommend that you read the whole of this manual before proceeding with use.

Gill products are in continuous development and therefore specifications may be subject to change and design improvements without prior notice.

The information contained in this manual remains the property of Gill Instruments and should not be copied or reproduced for commercial gain.

## 2. INTRODUCTION

This manual describes the operation of the WindMaster HS (1951-PK-020 + Options).

The units of wind speed, output rate, and formats are all user selectable.

The WindMaster HS, constructed from marine grade stainless steel 316, can perform measurements in wind speeds up to 45 m/s.

Options include up to four analogue input and four analogue output channels (14 bit resolution).

Units may additionally be calibrated in a wind tunnel to ISO 16622, traceable to national standards.

**WIND** software is available free from the Gill website [www.gillinstruments.com.co.uk](http://www.gillinstruments.com.co.uk). It is strongly recommended as it provides an easy, user-friendly interface.

### 3. PRINCIPLE OF OPERATION

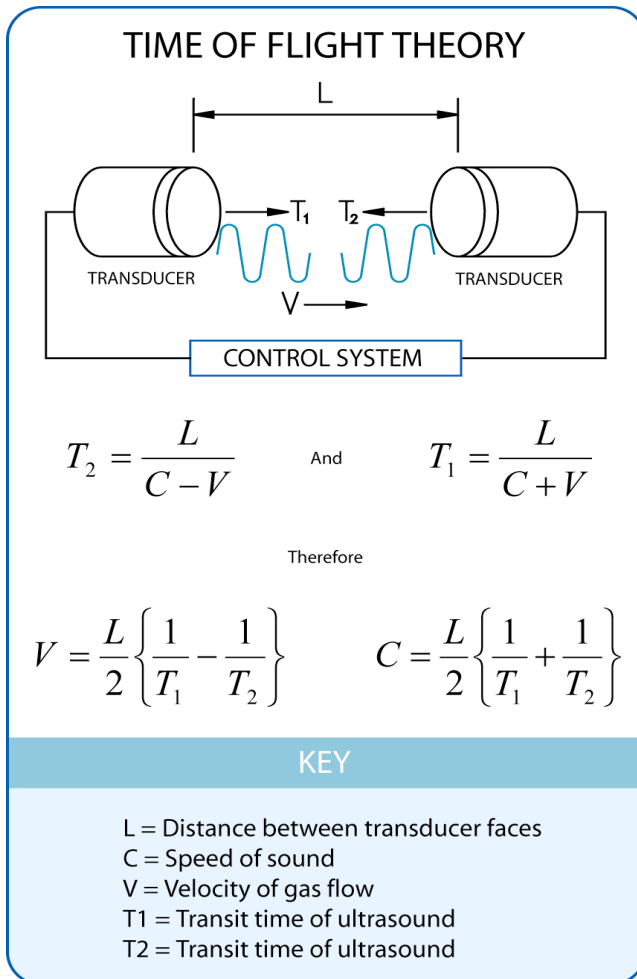

**Figure 1 Time of Flight details**

The WindMaster HS measures the times taken for an ultrasonic pulse of sound to travel from an upper transducer to the opposite lower transducer, and compares it with the time for a pulse to travel from lower to upper transducer.

Likewise times are compared between each of the other upper and lower transducers.

As Figure 1 shows, the air velocity along the axis between each pair of transducers can then be calculated from the times of flight on each axis.

This calculation is independent of factors such as temperature.

From the three axis velocities, the wind speed is calculated, as either signed U, V, and W, or as Polar and W.

It can be seen from Figure 1 that the speed of sound in air can be calculated from the times of flight. From this the sonic temperature can be derived from the formula  $T_{s1} = C_1^2 / 403$

Where

$T_{s1}$  = Sonic temperature

$C_1$  = Speed of sound

Note the formula does not account for the effect of Humidity

Figure 2 shows the direction and polarity of the U, V and W axes.

**Polar definition**

The wind speed in the UV plane, with direction in degrees from 0 to 359 °, with respect to the line of the Frame (which is normally aligned to North).

**U, V, and W axes definition**

U+ is defined as towards the direction in line with the frame as indicated in the diagram (default setting).

V+ is defined as towards the direction of 90° anti-clockwise from U+.

W+ is defined as vertically up the mounting shaft.

Note, when the unit is configured for the X2 setting the UV definition rotates 30 degrees anti-clockwise such that U+ is now in line with transducer axis 1.

**Figure 2 U, V and W Axis Definition**

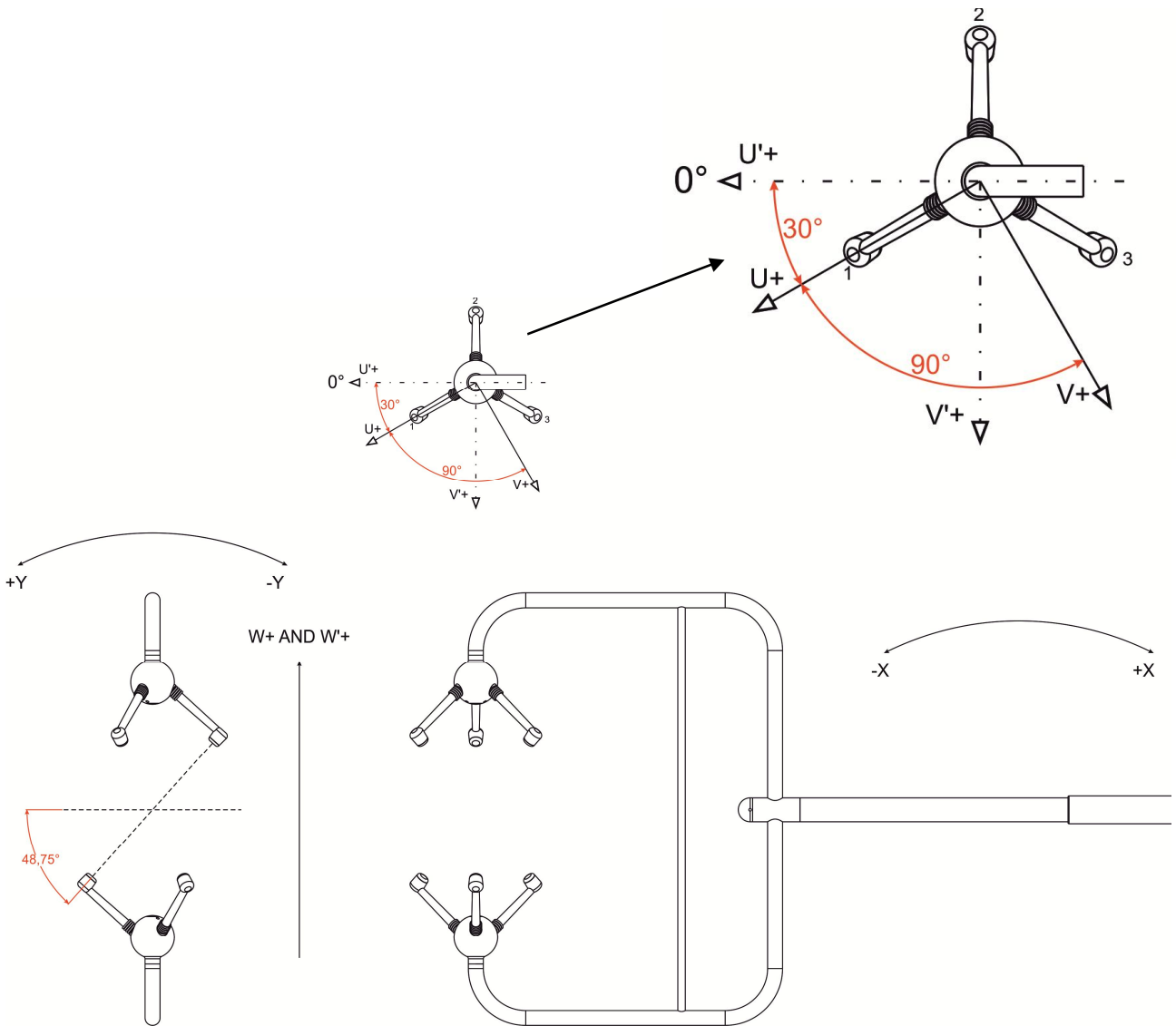

## Effects of temperature, barometric pressure, rainfall and humidity

The calculated u, v and w components are independent of temperature, pressure, rainfall & humidity within the operating parameters of the WindMaster HS.

The calculated sonic temperature/speed of sound should be corrected by the user for humidity to provide an indication of ambient temperature. The calculated Sonic Temperature/Speed of Sound is corrected internally for crosswind.

## Measurement sequence

All Modes except Syncpoll 1.

The table shows the firing sequence of the transducers.

Measurement Sequence

The sample rate is automatically selected to either 20Hz or 32Hz, depending on the output rate configured (see section 10.2).

| Measurement Period          | Max 50mS (at 20Hz) or 31.25mS (at 32Hz) |       |                    |       |                    |       | Next cycle                     |            |                                 |       |           |  |
|-----------------------------|---|-------|--------------------|-------|--------------------|-------|--------------------------------|------------|---------------------------------|-------|-----------|--|
| Ultrasonic Measurement Axis | 1<br>(2mS typical)                      |       | 2<br>(2mS typical) |       | 3<br>(2mS typical) |       | Maths Routine<br>(6mS Typical) | Spare Time | 1                               |       | 2         |  |
| Transducer Firing           | L > U                                   | U > L | L > U              | U > L | L > U              | U > L |                                |            | L > U                           | U > L | L > U etc |  |
| Analogue Input Measurement  | 1, 2, 3 and 4                           |       |                    |       |                    |       |                                |            |                                 |       |           |  |
| Serial Communication        |   |       |                    |       |                    |       |                                |            | Data from previous measurement. |       |           |  |

**L > U** Indicates lower to upper transducer firing.

**U > L** Indicates upper to lower transducer firing.

Analogue inputs are sampled synchronously at rates described in Para 8.3.

## Syncpoll 1

In this mode when a Poll command is received it will trigger a single 50mS or 31.25mS ultrasonic measurement as illustrated in the table above and at the same time will trigger a Wind measurement output resultant from the previous polled measurement.

**Notes:-**

**The minimum poll rate supported in this mode is 20Hz.**

**Analogue inputs are not supported in Syncpoll mode 1.**

## Signal processing

### Instantaneous Sampling

The WindMaster HS can be configured to output the sampled data direct at the selected output rate without any averaging - "Instantaneous Sampling". Alternatively data can be sampled at 20Hz or 32Hz and averaged (see section 10.2 Fx y and Px). This applies for wind data and speed of sound. All samples are transmitted with a status code.

### Retries Enabled

If this mode is selected, if a problem sample is detected, the unit will attempt another ultrasonic firing within the set time parameters.

### Calibration Enabled /Disabled

The on-board calibration (providing compensation for spar and transducer shadowing), can be disabled, returning the unit to raw, uncorrected operation

Selection of the above parameters is via using Gill Wind software package or using a Terminal Program to set the FX or Px command.

## 4. SPECIFICATION

|  | <b>WindMaster HS</b>  |
|--|---|
| <b>Outputs</b>   |   |
| Output rate  | 0.25, 0.5, 1, 2, 4, 5, 8, 10, 16, 20, 32 Hz                 |
| Sample rate (automatically selected)   | 20 or 32 Hz   |
| Units of measure   | m/s, mph, KPH, knots, ft/min                                |
| Format   | UVW or Polar ASCII or Binary                                |
| <b>Wind Speed</b>  |   |
| Range  | 0 - 45 m/s  |
| Resolution   | 0.01 or 0.001 m/s   |
| Accuracy (12 m/s) (Standard)*  | < 1.5% RMS  |
| Accuracy (12 m/s) (to special order)* #  | < 1.0 % RMS   |
| <b>Direction</b>   |   |
| Range  | 0 – 359.9°  |
| Resolution   | 1° or 0.1°  |
| Accuracy (12 m/s) (Standard)*  | 2°  |
| Accuracy (12 m/s) (to special order)* #  | 0.5°  |
| <b>Speed of Sound</b>  |   |
| Range  | 300 -370 m/s  |
| Resolution   | 0.01 m/s  |
| Accuracy   | < ± 0.5% @ 20°C   |
| <b>Power requirement</b>   | 9 -30 V dc, (55 mA @ 12 V dc) (excluding analogue outputs)  |
| <b>Digital output</b>  |   |
| Protocol<br>(ASCII and Binary)   | RS232, RS422, RS485 (2 wire point to point only)            |
| Baud rates   | 2400 – 57600  |
| <b>Analogue outputs (option 14 bit)</b>  |   |
| 4 channels   | Resolution 14 bit   |
| Selectable range   | User selectable full scale wind speed                       |
| Output type  | 0-20 mA, 4-20 mA, 0-5V, ±5V, ±2.5V                          |
| <b>Analogue inputs (option 14 bit)</b>   |   |
| Up to 4 single-ended<br>or 2 differential  | Resolution 14 bit   |
| Input range  | ±5 V  |
| <b>Sonic temperature</b>   |   |
| Range  | -40 °C to +70 °C  |
| Resolution   | 0.01 °C   |
| T <sub>s</sub> <sup>1</sup> Accuracy (≥ 1 Hz)  | <b>Eddy Covariance Quality</b>                              |
| T <sub>s</sub> Accuracy (slow response, used as<br>ambient thermometer, unit firmware<br>2329-700 or higher) | ± 2°C between -20° C to +30° C                              |
| <b>General</b>   |   |
| Weight   | 2.96 kg   |
| Size   | 956 x 347 x 120mm   |
| Environmental  | IP65  |
| Operating temperature  | -40 °C to +70 °C  |
| Storage Temperature  | -40 °C to +80 °C  |
| Humidity   | < 5 % to 100 %  |
| Precipitation  | Operation up to 300 mm / hour                               |
| EMC  | Emissions BS EN 61000 - 6 – 3, Immunity BS EN 61000 - 6 - 2 |

\* Accuracy specification applies for wind speed <32m/s and for wind incidence ≤ ± 150° in the horizontal plane and up to ± 50° from the horizontal.

# **Custom calibration** (to be specified when ordering, or unit can be returned for calibration) - Wind tunnel calibration is in accordance with ISO 16622 and traceable to national standards.



## 5. PRE-INSTALLATION

### 5.1. Equipment supplied

1951-PK 020 WindMaster HS System comprising of :-

|              |   |
|--------------|---|
| 1951-10-015  | WindMaster HS with integral 3 metre, 9 pair cable.  |
| 1951-PK-0019 | Installation kit, with four M8 stainless steel nuts, two M8 bolts, two M8 Spacers and four M8 shake-proof washers plus m4 screw, washer and terminal tag for earthing purposes. |
| 1951-30-045  | Travelling Case.  |
| 1000-10-034  | User Manual (this document) on a CD.  |

### 5.2. Software

**WIND** software is available on the supplied CD or free at [www.gillinstruments.com](http://www.gillinstruments.com), and is strongly recommended as it provides an easy, user-friendly interface.

### 5.3. Options

**Notes** These options must be specified when ordering the WindMaster HS.

*See Section 4 Specification for more detail*

| Option   | Comment  |
|--|--|
| Four Analogue outputs                                    | 14 bit   |
| Four Analogue inputs                                     | 14 bit   |
| Wind tunnel calibration, traceable to national standards | Units may also be returned to Gill for Wind tunnel calibration |

### 5.4. Accessories

| Item                                  | Part No     |
|---------------------------------------|-------------|
| Power Supply and Interface Unit (PCI) | 1189-PK-021 |
| WindMaster HS Interface Box           | 1951-PK-021 |

### 5.5. Packaging

Whilst the WindMaster HS is being moved to its installation site, the unit should be kept in its supplied Travelling Case. This should be retained for use if the unit has to be returned at any time.

### 5.6. Installation requirements

#### PC requirement

Gill Wind software will operate with any PC with Windows software from Windows XP onwards.

The PC must be fitted with a suitable interface to match the chosen communication format - RS232, RS422, or RS485. Alternatively a Gill Power Supply and Interface (PCI) may be used to convert RS422/485 output to RS232.

#### Other equipment

External analogue inputs / outputs must be compatible with the options fitted to the WindMaster HS.

*See Sections 8 and 9*

Interface box to enable extending the integral WindMaster HS lead.

**Connection**

- The unit is fitted with a 9 pair 3 metre long cable ending in stripped/tinned wire connections.
- The cable should be securely fixed with cable clamps or equivalent, so that the cable is not under stress at the plug.
- There are restrictions on the maximum cable lengths for correct operation. *See 6.4*
- See 6.3 for cable specification.

**Power supply**

- The WindMaster HS requires a DC supply of between 9 – 30 V DC.
- Typical current drain 55 mA @ 12 V (excluding analogue outputs)

## 6. INSTALLATION

### 6.1. Installation Guidelines

As with any sophisticated electronics, good engineering practice should be followed to ensure correct operation.

- Always check the installation to ensure the WindMaster HS is not affected by other equipment operating locally, which may not conform to current standards, e.g. radio/radar transmitters, boat engines, generators etc.
- Guidelines –
  - Avoid mounting in the plane of any radar scanner – a vertical separation of at least 2m should be achieved.
  - Radio transmitting antennas, the following minimum separations (all round) are suggested.
    - VHF IMM – 1m
    - MF/HF – 5m
    - Satcom – 5m (avoid likely lines of sight)
- Use cables recommended by Gill. If cables are cut and re-connected incorrectly (perhaps in a junction box) then EMC performance may be compromised if cable screen integrity is not maintained.
- Earth loops should not be created – wire the system in accordance with the installation guidelines.
- Ensure the power supply operates to the WindMaster HS specification at all times.
  
- Avoid turbulence caused by surrounding structures that will affect the accuracy of the WindMaster such as trees, masts and buildings.
- The World Meteorological Organisation makes the following recommendation:
- The standard exposure of wind instruments over level open terrain is 10m above the ground. Open terrain is defined as an area where the distance between the sensor and any obstruction is at least 10 times the height of the obstruction.
- If the sensor is to be mounted on a mast boom, part way up a tower or mast, then the boom should be at least twice as long as the minimum diameter or diagonal of the tower. The boom should be positioned on the prevailing wind side of the tower.
- If mounted on a pole then as a guide the distance from an adjacent pole should be 10 times the other pole diameter.
- If mounting on a building then as a guide the sensor should be mounted at a height of 1.5 times the height of the building.

### 6.2. Bench system test

**Note:** Prior to physically mounting the WindMaster HS in its final location, we strongly recommend that a bench system test be carried out to confirm the system is configured correctly, is fully functional and electrically compatible with the selected host system and cabling (preferably utilising the final cable length). The required data format, units, output rate, and other options should also all be configured at this stage.

### 6.3. Cable type

An RS232 / RS422 compatible cable (as appropriate) should be used, with the number of twisted pairs matching the application.

**Generic description** – Twisted pairs with drain wire, screened with aluminised tape, with an overall PVC sheath. Wire size 7/0.2mm (24 AWG), 22 awg wire may also be used.

The table shows some suitable manufacturers' references; other manufacturers' equivalents can be used.

| No. of pairs | Gill ref.   | Belden ref. | Batt electronics ref. |
|--------------|-------------|-------------|-----------------------|
| 9            | 026 - 02663 | 8774        | 91009                 |

The 9 pair cable (3m cable supplied) allows for the connection of all: -

Power inputs

Digital outputs

Analogue inputs

Analogue Outputs

Other example cable types (24awg) are:-

| No. of pairs | Gill ref.   | Belden ref. | Batt electronics ref. |
|--------------|-------------|-------------|-----------------------|
| 2            | -           | 9729        | -                     |
| 3            | 026 - 02660 | 9730        | 91030                 |
| 4            | 026-03156   | 9728        | 91199                 |

### 6.4. Cable length

The WindMaster HS is supplied with an integral 3 Metre, 9 pair, Belden 8774, 22awg, type cable fitted.

The maximum cable length is dependent on the chosen communication format (RS232, RS422 or RS485), the baud rate, and, to a lesser extent, on the cable type and the local electrical 'noise' level.

| Communication format       | Baud rate | Max. cable length   |
|----------------------------|-----------|---|
| RS232                      | 9600      | 6.5 m (20 ft) or if using Cat 5 cable see manufacturers recommendations |
| RS422/485                  | 9600      | 1 km (3200 ft)  |
| Analogue outputs - voltage | N/A       | 6.5 m (20 ft)   |
| Analogue outputs - current | N/A       | Resistance dependent (max 300 $\Omega$ )                                |

The table shows the typical maximum lengths at the given baud rates, using the recommended cable. If any problems of data corruption etc. are experienced, then a slower baud rate should be used. Alternatively, a thicker or higher specification cable can be tried.

### Grounding (Earthing)

To ensure correct operation, and for maximum protection against lightning, the anemometer **MUST** be correctly grounded (earthed) via its mountings. Inadequate grounding will degrade anemometer performance, particularly in the presence of radio frequency interference.

The unit **MUST** be connected to an appropriate grounding point with a minimum of 6mm<sup>2</sup> copper wire. The primary earth for the anemometer must be provided via the mounting screws and not via the cable screens.

### Optional WindMaster HS Cable Interface box (Part 1951-PK-021)

An optional interface box may be purchased to extend the integral WindMaster HS 9 pair, 3 metre long lead.

The Interface Box centre positioned M20 gland is suitable for the WindMaster HS cable (cables 8-13mm outer diameter) and the other two M16 glands for an Analogue Input/Output cable or Digital Output and Power cable (5-10mm outer diameter).

There is no active circuitry within this Interface box which contains 2 off 8 way terminal blocks for terminating stripped/tinned cable wires.

Connect Cable screens/drains to the terminal tags provided.

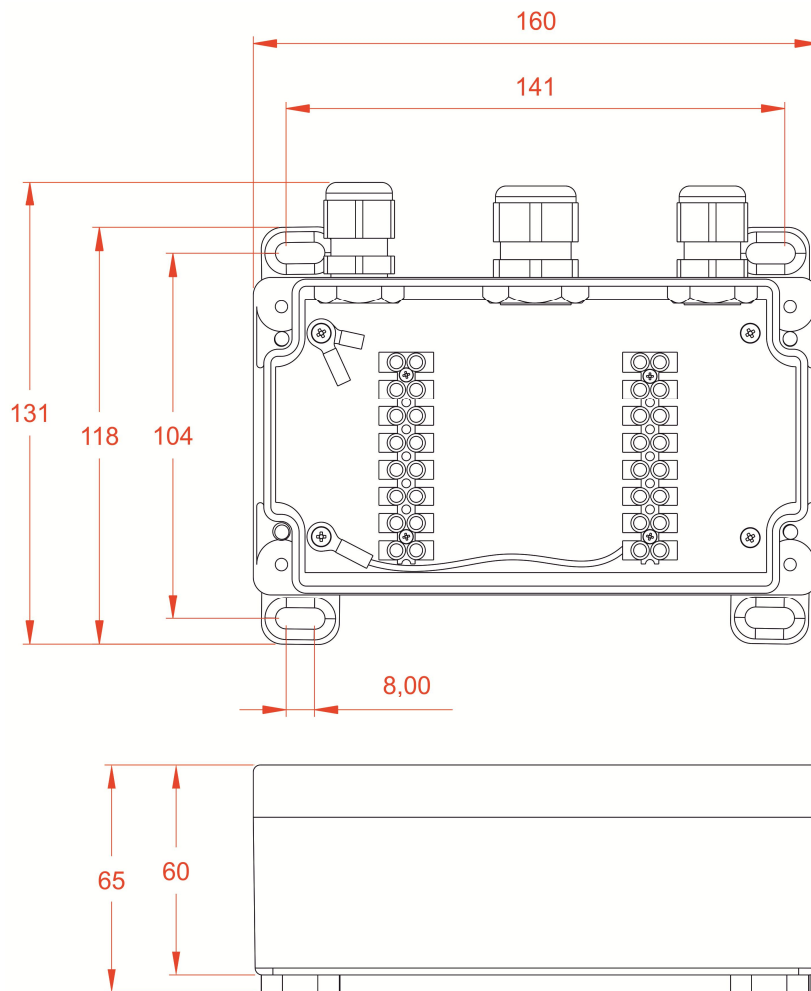

## 6.5. Connections

### Important

- Do NOT join any of the cores of the cable together. Any cores not used should be isolated.
- Do NOT connect the unit's analogue output 0V or power 0V to the screen or ground / earth.
- The integrity of the screen of each pair should be maintained throughout the cable run.
- Avoid long grounding loops.

For maximum lightning protection it is essential that the unit be properly grounded via its mounting base.

| Function             | Remarks   | Pair Number | Colour |
|----------------------|---|-------------|--------|
| TX +                 | Anemometer Transmit                                   | 1           | Green  |
| TX -                 | Anemometer Transmit                                   | 1           | Black  |
| RX +                 | Anemometer Receive                                    | 2           | White  |
| RX -                 | Anemometer Receive                                    | 2           | Black  |
|                      |   |             |        |
| Power V+             | 9 – 30 V dc   | 3           | Red    |
| Power 0V             | Use also for digital comms 0V                         | 3           | Black  |
|                      |   |             |        |
| Communications Mode  | Polarity sets Comms mode Connect to V+ for RS232      | 4           | Blue   |
| Analogue Ground      | Common Analogue Ground                                | 4           | Black  |
|                      |   |             |        |
| Analogue Input 1     |   | 6           | Brown  |
| Analogue Input 2     |   | 6           | Black  |
| Analogue Input 3     |   | 7           | Orange |
| Analogue Input 4     |   | 7           | Black  |
|                      |   |             |        |
| Analogue Output 1    |   | 8           | White  |
| Analogue Output 2    |   | 8           | Red    |
| Analogue Output 3    |   | 9           | Green  |
| Analogue Output 4    |   | 9           | Red    |
|                      |   |             |        |
| Twisted Pair Screens | Are connected internally to the WindMaster HS chassis |             |        |

### 6.6. Connection to a PC using RS 232

**Notes**

1. Using RS232, the cable length for reliable operation is limited to 6.5m (20ft) @ 9600 Baud. See 6.4
2. For longer cable runs, we recommend using the WindMaster HS configured with RS422 output, and a RS422/232 converter at the PC. See 6.7
3. Ensure WindMaster HS is configured for AUTO or RS232. See Section 10 Configuring.
4. Configure WindMaster HS for RS 232 by linking Comms Mode to V+.

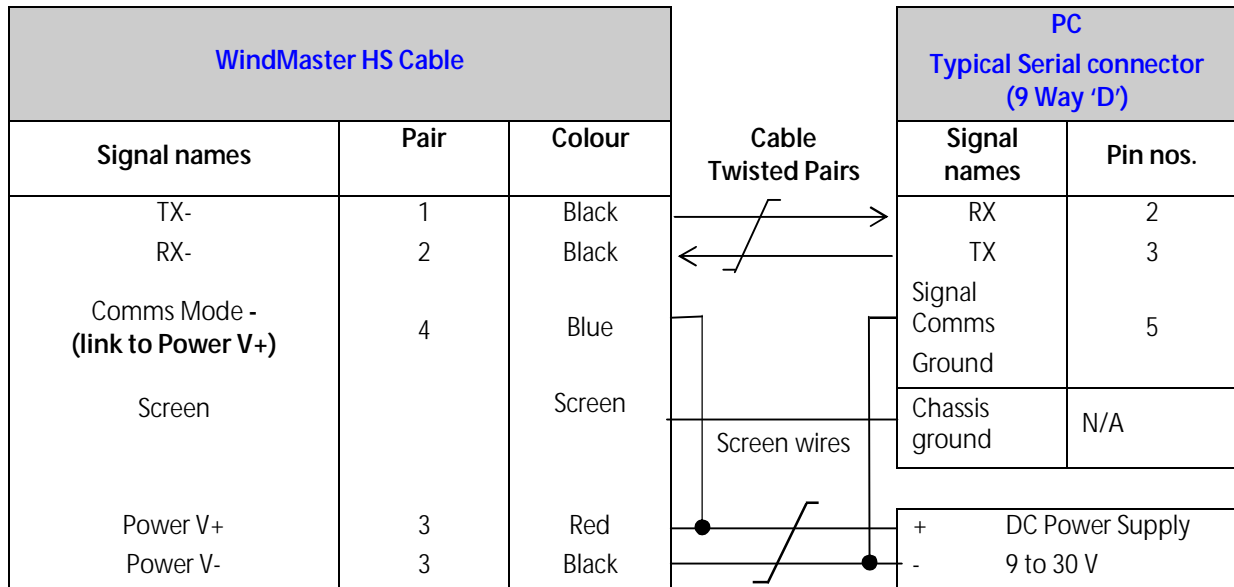

### 6.7. Connection to a PC using RS 422

**Notes**

1. The PC must be fitted with an internal or external RS422 / RS232 converter.
2. Configure WindMaster HS for RS 422 by linking Comms Mode to V-.

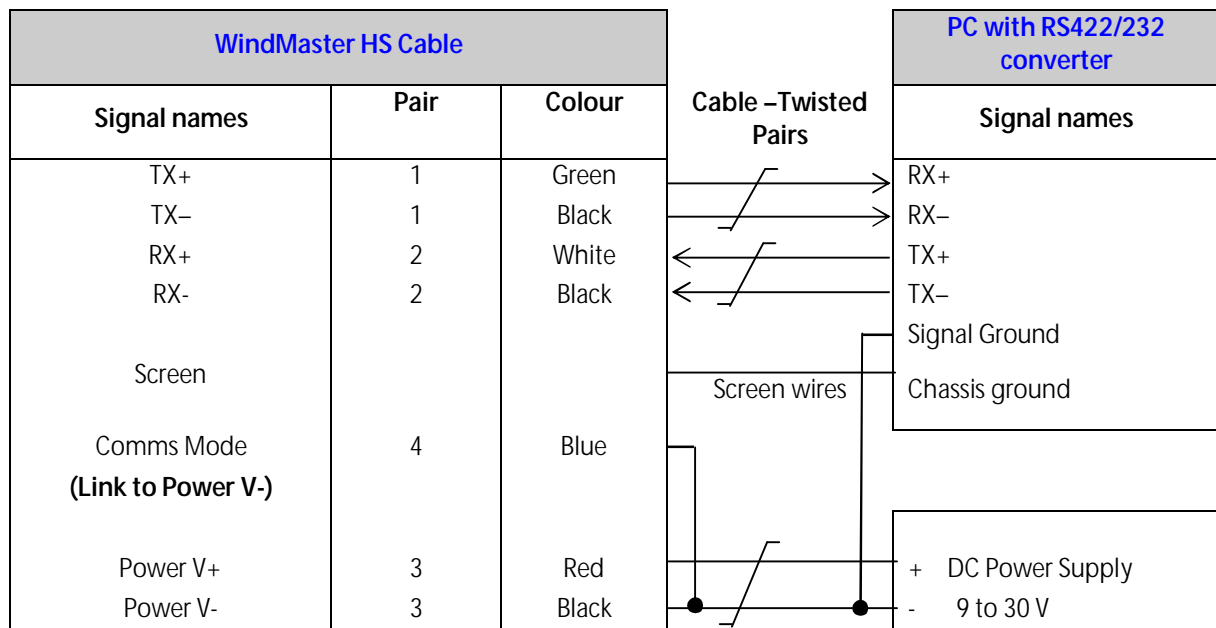

**6.8. RS422 Connection to a PC via a Power and Communications Interface (1189-PK-021).**

Dependent upon system requirements the WindMaster HS unit can be operated with the Power and Communications and Interface unit (PCI), which can be ordered as an optional extra. Connect WindMaster HS via RS422 port; then connect computer to RS232 port on PCI.

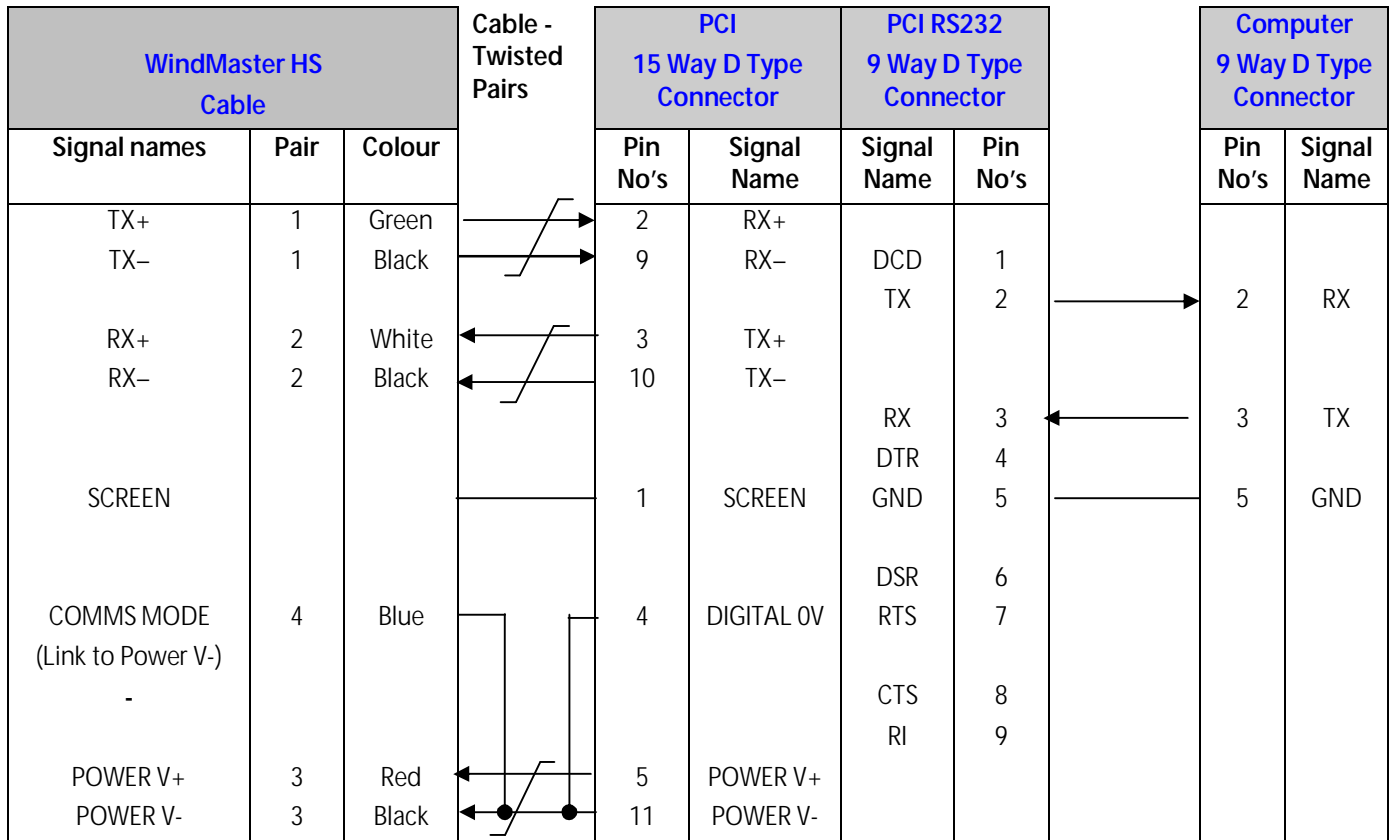

**Environmental**

The Desktop PCI is intended for use in a protected environment and provides interfacing to a single anemometer. RS232, and RS422 ports are provided. The PCI is not intended for outdoor use.

**PCI Electrical Power Requirements**

- 1) 100Vac - 120Vac, 10VA for the 115V switch position (Power PCI from Mains Supply).
- 2) 200Vac - 250Vac, 10VA for the 230V switch position (power PCI from Mains Supply).
- 3) 9 - 30Vdc, 55mA excluding analogue outputs (anemometer), power PCI from external DC supply.  
8 - 15Vdc, 50mA max (interface) power PCI from external DC supply.

3 fuses protect the unit:

1. Externally accessible 1 A (T) for 115/230v operation
2. Internally accessible 500 mA (T) AUX  
500 mA (T) ANEM

**PCI Operation.**

There are three Red LED's on the PCI front panel.

When the PCI box is powered the Power LED will illuminate.

When a WindMaster HS is connected as above to the PCI box and is set to output continuous data the PCI box RX LED will flash on/off at the WindMaster HS output rate thus giving a good indication that the WindMaster HS output is wired to the PCI box correctly and outputting RS422 data correctly.

If the PCI RS 232 connection is connected to a computer then when a terminal programme is opened and commands sent by a PC keypad or program to the PCI box its TX LED will illuminate intermittently indicating a good connection between the PC and PCI box.



### Connector Pin and Cable Assignments for PCI

| Anemometer Connector 15 - Way |                           |
|-------------------------------|---------------------------|
| Pin                           | Designation               |
| 1                             | Screen                    |
| 2                             | RS422_RX+                 |
| 3                             | RS422_TX+                 |
| 4                             | Digital 0V, Signal ground |
| 5                             | Supply V+                 |
| 6                             | Not used                  |
| 7                             | Not used                  |
| 8                             | Not used                  |
| 9                             | RS422_RX-                 |
| 10                            | RS422_TX-                 |
| 11                            | Supply V-                 |
| 12                            | Not used                  |
| 13                            | Not used                  |
| 14                            | Not used                  |
| 15                            | Not Used                  |

| DC Supply 4 - Way |               |
|-------------------|---------------|
| Pin               | Designation   |
| 1                 | Interface V+  |
| 2                 | Interface V-  |
| 3                 | Anemometer V- |
| 4                 | Anemometer V+ |

| RS232 Output - 9 way |               |
|----------------------|---------------|
| Pin                  | Designation   |
| 1                    | DCD           |
| 2                    | TX data       |
| 3                    | RX data       |
| 4                    | DTR           |
| 5                    | Signal Ground |
| 6                    | DSR           |
| 7                    | RTS           |
| 8                    | CTS           |
| 9                    | RI            |

| RS422/Network Input/Output 9 Way |               |
|----------------------------------|---------------|
| Pin                              | Designation   |
| 1                                | Not connected |
| 2                                | Not connected |
| 3                                | Not connected |
| 4                                | RS422_RXA (-) |
| 5                                | Signal ground |
| 6                                | RS422_TXA (-) |
| 7                                | RS422_TXB (+) |
| 8                                | RS422_RXB (+) |
| 9                                | Earth         |

### PCIA Box (1189-PK-020) WindMaster HS Analogue Output Connections.

If a PCIA box is available then a WindMaster HS with Analogue Output option connections can be routed from the 15 Way D type Input connector directly to the Auxiliary 9 way D type Output connector. (Note: The PCIA box does not convert the digital output from the WindMaster HS to analogue outputs).

| WindMaster HS Cable |      |        | PCIA Box 15 – Way<br>D Type Connector | PCIA Auxiliary or Sync<br>Out 9 Way D Type<br>Connector   |
|---------------------|------|--------|---------------------------------------|---|
| Function            | Pair | Colour | Pin                                   | Pin   |
| Analogue Output 1   | 8    | White  | 6                                     | 6   |
| Analogue Output 2   | 8    | Red    | 8                                     | 7   |
| Analogue Output 3   | 9    | Green  | 15                                    | 8   |
| Analogue Output 4   | 9    | Red    | 12                                    | 9   |
| Analogue Ground     | 4    | Black  | 13                                    | 2, 3, 4 and 5 (Grounds for Analogues 1 to 4 respectively) |

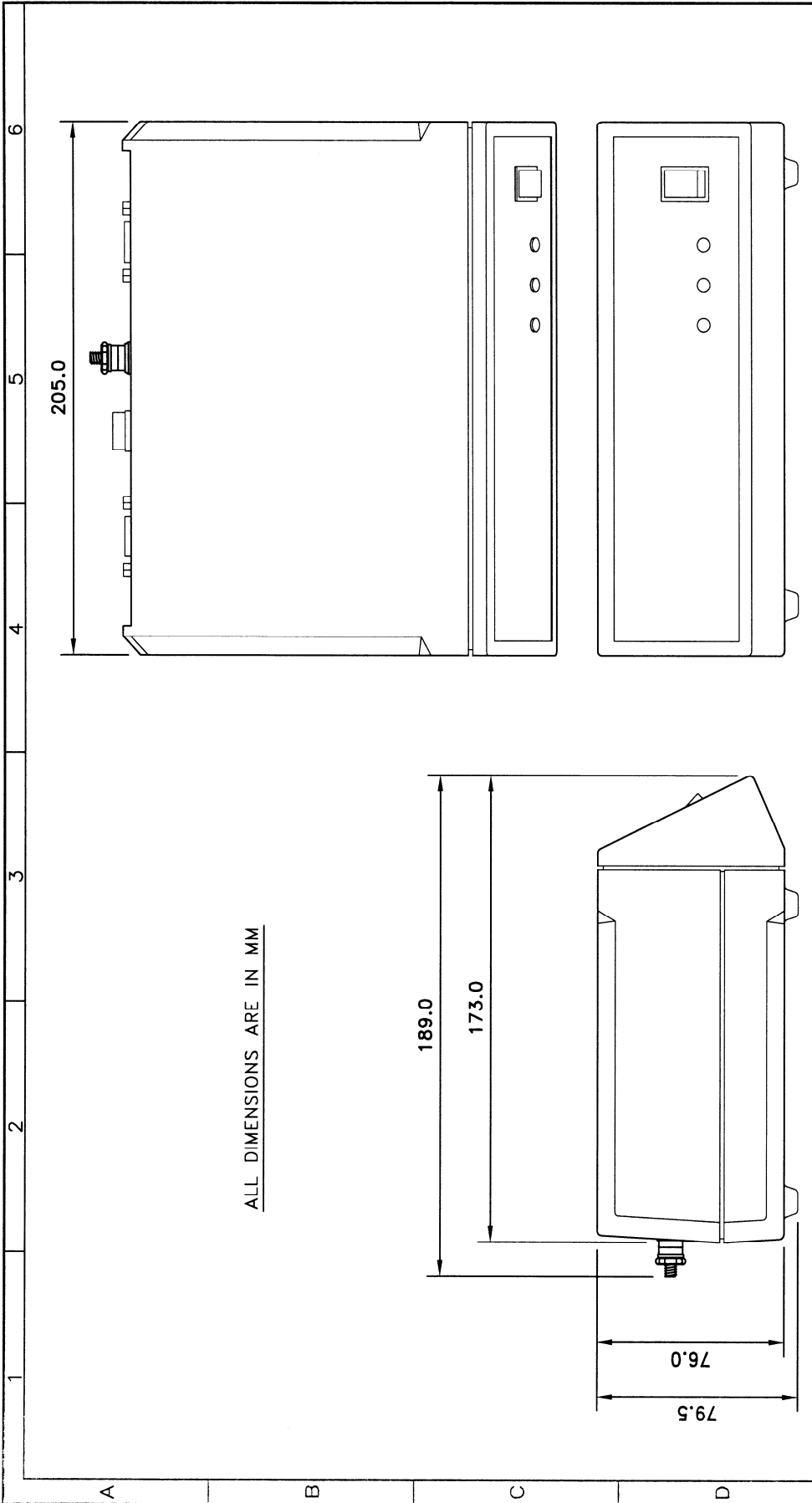

ALL DIMENSIONS ARE IN MM

| ISS. | DESCRIPTION  | CHANGE NO. | APPD. | DATE     | GILL ELECTRONIC RESEARCH & DEVELOPMENT LYMINGTON, ENGLAND. © |  | SCALE                      | MATERIAL | USED ON             |
|------|--|------------|-------|----------|--|--|----------------------------|----------|---------------------|
| 1    | FIRST RELEASE  | F1045      |       | 18/11/96 |  |  | 1:2                        | FINISH   | DRAWN R.J.P.        |
| 2    | DIM'N 189.0mm WAS 186.0mm, 205.0mm WAS 198.0mm. AND 76.0mm WAS 74.0mm. | 1639       |       | 18/5/98  |  |  | GENERAL TOL.               |          | CHECKED             |
|      |  |            |       |          |  |  | TITLE                      |          | DATE 15-11-96       |
|      |  |            |       |          |  |  | INDOOR PCI UNIT DIMENSIONS |          | DRG. NO. 1189-K-022 |
|      |  |            |       |          |  |  | A4                         |          |                     |

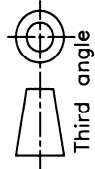

### 6.9. Using RS485 2 Wire Point to Point only

#### Notes

1. Set up the WindMaster HS operating configuration before wiring for RS485 mode.
2. WindMaster HS **must** be configured for RS485 by linking Comms Mode line to V-.
3. WindMaster HS **must** be in a Polled mode.
4. The Master unit can be any suitable control device fitted with a RS485 interface card, such as a PC or Data logger.
5. Analogue Outputs are also simultaneously available.
6. The maximum poll rate is 10Hz in default SyncPoll 0 mode.
7. The WindMaster HS can only be used in 2-wire mode in a Point-to-Point configuration; it cannot be networked with other devices on the 2-wire connection.

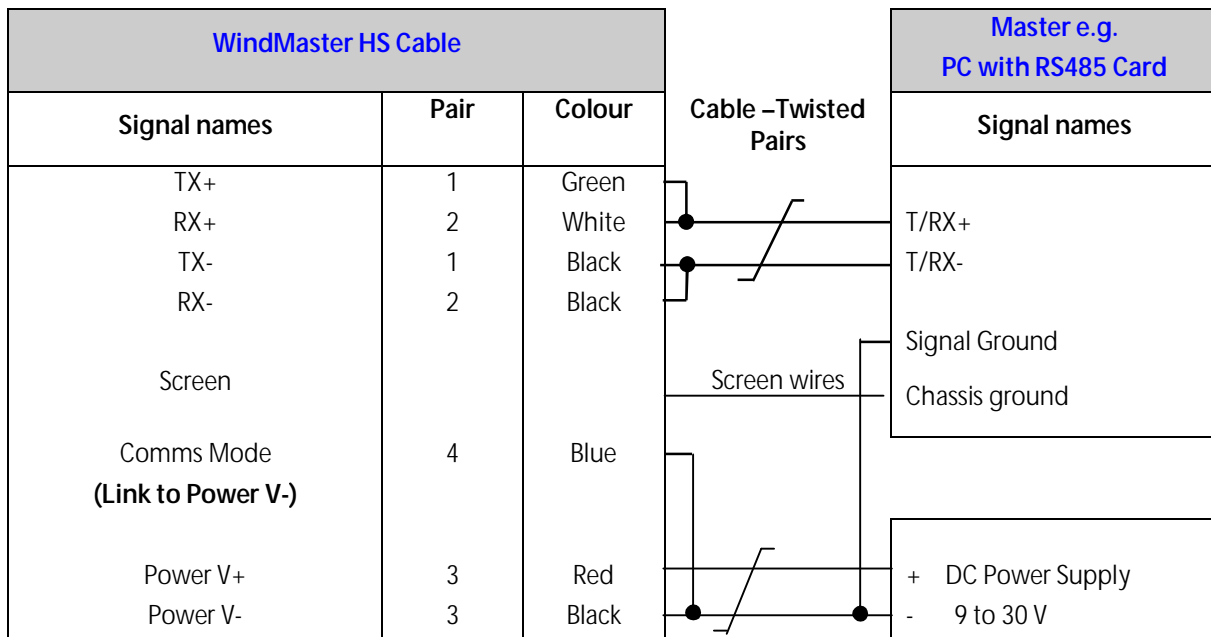

**6.10. Mechanical installation**

**Before installing**, it is strongly recommended that a bench test is carried out.

**Location**

Select a position so that the unit is clear of any structure, which may obstruct the airflow or induce turbulence.

Do NOT mount the WindMaster HS in close proximity of high-powered radar or radio transmitters. A site survey may be required if there is any doubt about the strength of external electrical noise.

**Corrosion**

Careful note should be taken of the possibility of galvanic corrosion by incorrect mounting. It is vital that only stainless steel fixings are used and that the instrument is insulated from the mounting surface with the rubber gasket. This will ensure that the anemometer will provide long service under extreme conditions such as marine environments.

**Sealing**

Provision should be made to seal the three M4 base nuts adjacent to the Earthing Point (with RTV etc.) and fit a cable gland/s (i.e. with a rubber boot) to prevent water ingress.

**Mounting and Alignment**

Normally the WindMaster HS is mounted horizontally, for a horizontal Measuring Plane.

Align the unit as per the following illustration, so that the upper transducer sphere is directly above the lower transducer sphere.

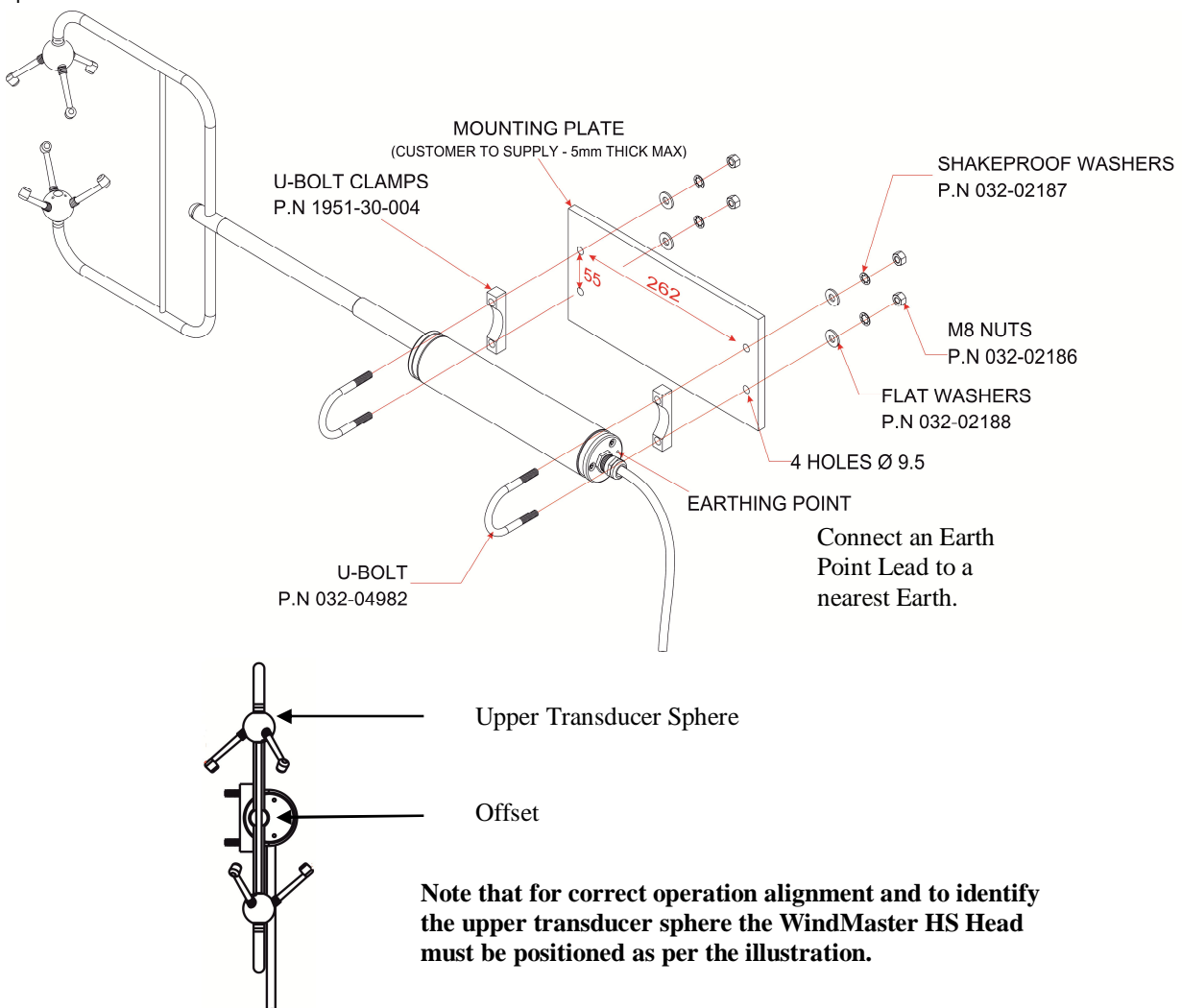

### Grounding (Earthing) See previous illustration

For protection against lightning the WindMaster HS **MUST** be earthed via its mountings. An M4x8mm Pozi Pan Screw and associated crinkle washer is provided together with a M4 Terminal Tag. The screw is inserted into the thread provided adjacent to the cable gland outlet.

**The unit MUST be connected to an appropriate grounding point with a minimum of 6mm<sup>2</sup> copper wire.**

### Cable strain relief

Fit strain relief when installing such that the weight of the cable is supported and does not put a strain on the cable at the anemometer gland outlet.

### WindMaster HS Dimensions

Overall dimensions are as follows:-

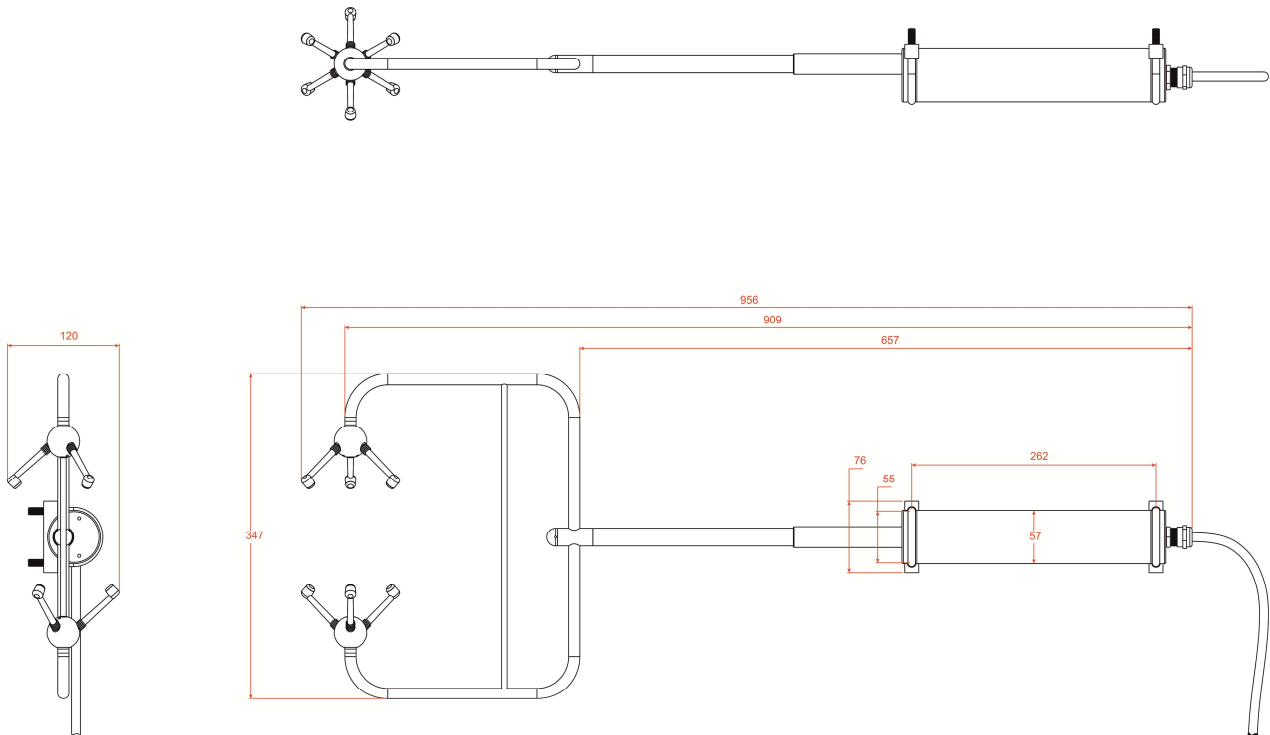

Note: The Cable length is 3 Metres long

## 7. MESSAGE FORMATS

On applying power to the WindMaster HS, it will automatically operate in the Measurement Mode and provide wind measurements in one of the following formats:

- Mode 1 – ASCII, UVW, Continuous
- Mode 2 – ASCII, Polar, Continuous (**default format**)
- Mode 3 – ASCII, UVW, Polled
- Mode 4 – ASCII, Polar, Polled
- Mode 7 – Binary, Polar, Short
- Mode 8 – Binary, UVW, Short
- Mode 9 – Binary, Polar, Long
- Mode 10 – Binary UVW, Long

**Note:** In this Section, the default settings are shown in **Bold**.

The user need not necessarily use a terminal emulator to store and analyse data being sent by the Anemometer. This section describes the modes and format of the data output to enable specific interfacing software to be generated by the user.

**Information on how to change the formats and all the settings follows in Section 10 CONFIGURING.**

### 7.1. Mode 1– ASCII, UVW, Continuous

(a) Mode 1, Normal Resolution (J1).

**ASCII, UVW, Continuous, Speed of Sound On, Sonic Temp On, [Optional Analogue inputs On]**

In this mode, the wind speed outputs are given as signed (i.e. positive or negative) speeds along the U axis, V axis and the W (vertical) axis.

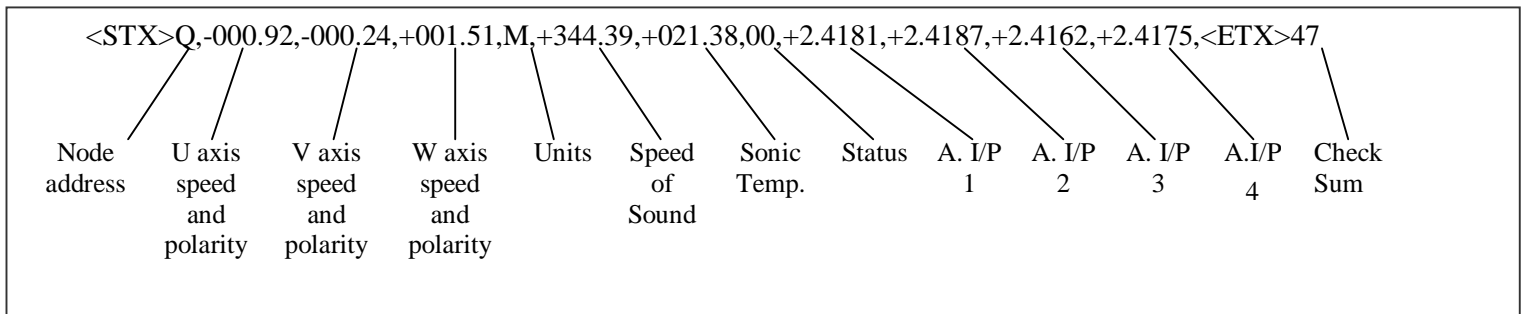

Format for software configuring is: -

<STX><ID>,±UUU.UU,±VVV.VV,±WWW.WW,U,±CCC.CC,±TTT.TT,SS,[±1.1111,±2.2222,±3.3333,±4.4444],±PP.PPC,<ETX>CC<CR><LF>

Where:

- <STX> - Start of string character (ASCII value 2)
- <ID> - Anemometer Identification (A-Z)
- ±UUU.UU - 'U' axis velocity 0.01ms<sup>-1</sup> units
- ±VVV.VV - 'V' axis velocity 0.01ms<sup>-1</sup> units
- ±WWW.WW - 'W' axis velocity 0.01ms<sup>-1</sup> units
- U - Units (M=m/s, N=knots, P=mph, K=kph)
- ±CCC.CC - Speed of Sound in 0.01ms<sup>-1</sup> units
- ±TTT.TT - Sonic Temperature in Degrees C.
- SS - Status data (Codes 00 to 0B)
- ±1.1111 - Analogue input 1 in volts
- ±2.2222 - Analogue input 2 in volts
- ±3.3333 - Analogue input 3 in volts
- ±4.4444 - Analogue input 4 in volts
- <ETX> - End of string character (ASCII value 3)
- CC - Checksum of all Characters between <STX> and <ETX> (HEX byte)
- <CR><LF> - Carriage Return and Line Feed

**<STX>**

Start of string character (ASCII value 2)

**WindMaster HS Identification node address**

The default setting is 'Q'.

**Horizontal wind speed**

Shows the wind speed in the U / V Plane. *See Fig 2*

**Vertical wind speed**

Shows the magnitude of wind speed in the W axis. *See Fig 2*

**Units**

The Units identifier shows the units in which the wind speeds are measured.

| Units                       | Identifier |
|-----------------------------|------------|
| Metres per second (default) | M          |
| Knots                       | N          |
| Miles per hour              | P          |
| Kilometres per hour         | K          |
| Feet per minute             | F          |

**Speed of Sound (SOS)**

If enabled, this is displayed in metres per second.

**Sonic temperature**

If enabled, this is displayed in degrees C.

**Status**

This indicates either correct operation - Code 00 - or status code. *See 11.4 for explanation of codes.*

**Analogue Inputs (order option)**

If enabled, the four Analogue inputs are an order option (see Para 8.1)

**Checksum**

This enables the host system to check that the data has been correctly received. This is the EXCLUSIVE – OR of the bytes between (and not including) the <STX> and <ETX> characters reported as ASCII Hex.

**<ETX>**

End of string character (ASCII value 3)

**Output rate (not displayed)**

The WindMaster HS delivers wind information at rates from 1 (default setting) to 32 outputs / second. [The sample rate (20 or 32 Hz) is chosen automatically to be an appropriate multiple of the output rate.] Data can be instantaneous or averaged (see section 10)

**(b) Mode 1 (High Resolution (J2))**

**ASCII, UVW, Continuous, Speed of Sound On, Sonic Temp On, [Optional Analogue inputs On]**

<STX><ID>,±UUU.UUU,±VVV.VVV,±WWW.WWW,U,±CCC.CC,±TTT.TT, SS,[±1.1111,±2.2222,±3.3333,±4.4444],<ETX>CC<CR><LF>

Where:

- <STX> - Start of string character (ASCII value 2)
- <ID> - Anemometer Identification (A-Z)
- ±UUU.UUU - 'U' axis velocity 0.001ms<sup>-1</sup> units
- ±VVV.VVV - 'V' axis velocity 0.001ms<sup>-1</sup> units
- ±WWW.WWW - 'W' axis velocity 0.001ms<sup>-1</sup> units
- U - Units (M=m/s)
- ±CCC.CC - Speed of Sound in 0.01ms<sup>-1</sup> units
- ±TTT.TT - Sonic Temperature in Degrees C.
- SS - Status data (Codes 00 to 0B)
- ±1.1111 - Analogue input 1 in volts
- ±2.2222 - Analogue input 2 in volts
- ±3.3333 - Analogue input 3 in volts
- ±4.4444 - Analogue input 4 in volts
- <ETX> - End of string character (ASCII value 3)
- CC - Checksum of all Characters between <STX> and <ETX> (HEX byte)
- <CR><LF> - Carriage Return and Line Feed

**7.2. Mode 2 – ASCII, Polar, Continuous (Default)**

**(a) Mode 2 (Normal Resolution Shown J1)**

**ASCII, Polar+W, Continuous, Speed of Sound On, Sonic Temp On, [Optional Analogue inputs On]**

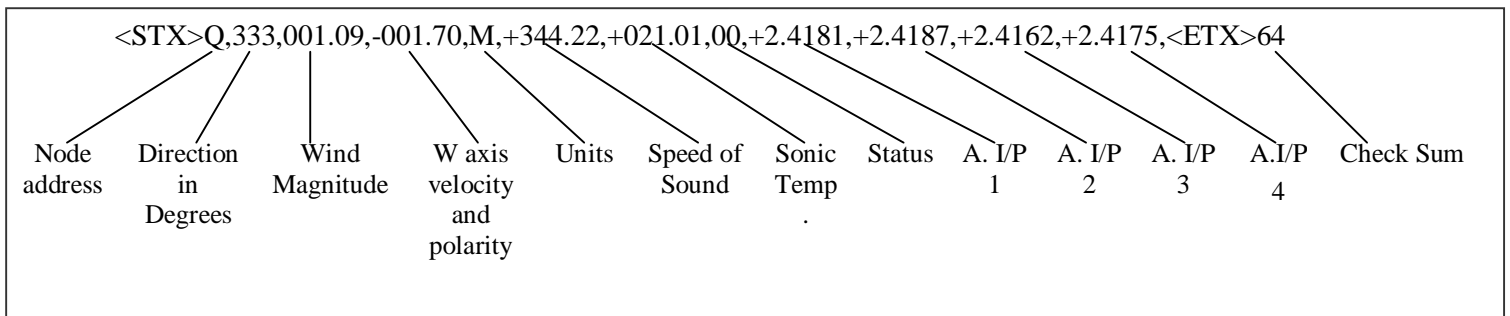

Format for software configuring is:-

<STX><ID>,DDD.MMM.MM,±WWW.WW,U,±CCC.CC,±TTT.TT,SS,[±1.1111,±2.2222,±3.3333±4.4444], ±PP.PPC,<ETX>CC<CR><LF>

Where:

- <STX> - Start of string character (ASCII value 2)
- <ID> - Anemometer Identification (A-Z)
- DDD - Direction in degrees
- MMM.MM - Wind Magnitude
- ±WWW.WW - 'W' axis velocity 0.01ms<sup>-1</sup> units
- U - Units (M=m/s, N=knots, P=mph, K=kph)
- ±CCC.CC - Speed of Sound in 0.01ms<sup>-1</sup> units
- ±TTT.TT - Sonic Temperature in Degrees C.
- SS - Status data (Codes 00 to 0B)
- ±1.1111 - Analogue input 1 in volts
- ±2.2222 - Analogue input 2 in volts
- ±3.3333 - Analogue input 3 in volts
- ±4.4444 - Analogue input 4 in volts
- <ETX> - End of string character (ASCII value 3)
- CC - Checksum of all Characters between <STX> and <ETX> (HEX byte)
- <CR><LF> - Carriage Return and Line Feed

Parameters are as described in Para 7.1 except that :-



## Horizontal wind direction

Indicated in degrees, from 0 to 359°, with respect to the WindMaster HS North marker.

In fixed field mode and when the wind speed is below 0.05 metres/sec, the direction will not be calculated, but the last calculated direction above 0.05 m/s will be output (the threshold of 0.05 m/s is the default setting; it is user-configurable).

### (b) Mode 2 (High Resolution Shown J2)

**ASCII, Polar+W, Continuous, Speed of Sound On, Sonic Temp On, [Optional Analogue inputs On]**

```
<STX><ID>,DDD.D,MMM.MMM,±WWW.WWW,U,±CCC.CC,±TTT.TT,SS,[±1.1111,±2.2222,±3.3333
±4.4444],<ETX>CC<CR><LF>
```

Where:

|           |     |   |
|-----------|-----|---|
| <STX>     | -   | Start of string character (ASCII value 2)                     |
| <ID>      | -   | Anemometer Identification (A-Z)                               |
| DDD.D     | -   | Direction in degrees  |
| MMM.MMM   | -   | Wind Magnitude  |
| ±WWW.WWW- | 'W' | axis velocity 0.001ms <sup>-1</sup> units                     |
| U         | -   | Units (M=m/s)   |
| ±CCC.CC   | -   | Speed of Sound in 0.01ms <sup>-1</sup> units                  |
| ±TTT.TT   | -   | Sonic Temperature in Degrees C.                               |
| SS        | -   | Status data (Codes 00 to 0B)                                  |
| ±1.1111   | -   | Analogue input 1 in volts                                     |
| ±2.2222   | -   | Analogue input 2 in volts                                     |
| ±3.3333   | -   | Analogue input 3 in volts                                     |
| ±4.4444   | -   | Analogue input 4 in volts                                     |
| <ETX>     | -   | End of string character (ASCII value 3)                       |
| CC        | -   | Checksum of all Characters between <STX> and <ETX> (HEX byte) |
| <CR><LF>  | -   | Carriage Return and Line Feed                                 |

### 7.3. Mode 3–ASCII, UVW, Polled.

#### Mode 3 (Normal Resolution Shown)

**ASCII, UVW, Polled, Speed of Sound On, Sonic Temp On, [Optional Analogue inputs On]**

```
<STX><ID>,±UUU.UU,±VV.VV,±WWW.WW,U,±CCC.CC,
±TTT.TT,SS,[±1.1111,±2.2222,±3.3333±4.4444],<ETX>CC<CR><LF>
```

Where:

|          |   |   |
|----------|---|---|
| <STX>    | - | Start of string character (ASCII value 2)                     |
| <ID>     | - | Anemometer Identification (A-Z)                               |
| ±UUU.UU  | - | 'U' axis velocity 0.01ms <sup>-1</sup> units                  |
| ±VV.VV   | - | 'V' axis velocity 0.01ms <sup>-1</sup> units                  |
| ±WWW.WW  | - | 'W' axis velocity 0.01ms <sup>-1</sup> units                  |
| U        | - | Units (M=m/s, N=knots, P=mph, K=kph)                          |
| ±CCC.CC  | - | Speed of Sound in 0.01ms <sup>-1</sup> units                  |
| ±TTT.TT  | - | Sonic Temperature in Degrees C.                               |
| SS       | - | Status data (Codes 00 to 0B)                                  |
| ±1.1111  | - | Analogue input 1 in volts                                     |
| ±2.2222  | - | Analogue input 2 in volts                                     |
| ±3.3333  | - | Analogue input 3 in volts                                     |
| ±4.4444  | - | Analogue input 4 in volts                                     |
| <ETX>    | - | End of string character (ASCII value 3)                       |
| CC       | - | Checksum of all Characters between <STX> and <ETX> (HEX byte) |
| <CR><LF> | - | Carriage Return and Line Feed                                 |

## Polled Mode Notes General

Polled mode is only applicable to a single point to point system.

When in the Polled mode, an output is only generated when the host system sends a Poll signal to the WindMaster HS consisting of the WindMaster HS Unit Identifier – that is, the relevant letter A – Z.

The default setting is 'Q'.

The commands available in Polled Mode are :

| Description                           | Command    | WindMaster HS Response   |
|---------------------------------------|------------|--|
| WindMaster HS Unit Identifier         | A ..... Z  | Wind speed output generated  |
| Enable Polled mode                    | ?          | (none)   |
| Disable Polled mode                   | !          | (none)   |
| Request WindMaster HS Unit Identifier | &          | A ..... Z (as configured)  |
| Enter Configuration mode              | *<N>       | CONFIGURATION MODE   |
| Default Poll Mode                     | Syncpoll 0 | Ultrasonic firings take place in the background at the output rate. Data Output is asynchronous to the poll command. |
| Single Ultrasonic Firing Poll mode    | Syncpoll 1 | A single ultrasonic firing result is output. It is triggered/synchronised to the poll command.                       |

\* Where <N> is the Unit Identifier.

It is suggested that in polled mode the following sequence is used for every poll for information.

? Ensures that the Sensor is enabled to cover the event that a power down has occurred.

A-Z Appropriate unit designator sent to retrieve a line of data.

! Sent to disable poll mode and reduce possibility of erroneous poll generation.

If the unit is powered down after use or upon switch on then allow 3 seconds from switch on before sending poll commands.

Maximum poll rate for all modes except Syncpoll 1 is 10Hz.

## Syncpoll 0 Mode Notes (Default)

### Default Syncpoll 0 is set up as follows: -

Open Wind Software.

Type \* or \*<N> (if already in a polled mode) to enter CONFIGURATION MODE.

Type Syncpoll 0 and press Enter (note there is a space between Syncpoll and 0).

Type Q and press Enter to go to SyncPoll 0 measurement mode.

Ultrasonic firings take place in the background; receipt of a poll command will trigger an asynchronous Wind measurement output resultant from the previous measurements. The maximum Poll command rate is 10Hz.

To check the current syncpoll setting when in configuration mode type Syncpoll and press return. The unit will respond with 1 or 0.

## Syncpoll 1 Mode Notes

### Syncpoll 1 is set up as follows:-

Open Wind Software.

Type \* or \*<N> (if already in a polled mode) to enter CONFIGURATION MODE.

Type Syncpoll 1 and press Enter (note there is a space between Syncpoll and 1).

Type Q and press Enter to go to Syncpoll 1 measurement mode.

Receipt of poll command will trigger a single 50mS or 31.25mS ultrasonic measurement and at the same time will trigger a Wind measurement output resultant from the previous polled measurement. The minimum Poll command rate is 20Hz.

To check the current Syncpoll setting when in configuration mode type Syncpoll and press return. The unit will respond with 1 or 0.

Analogue inputs are not supported in Syncpoll 1 mode.

#### 7.4. Mode 4 –ASCII, Polar, Polled.

##### Mode 4 (Normal Resolution Shown)

ASCII, Polar+W, Polled, Speed of Sound On ,Sonic Temp On, [Analogue inputs On]

<STX><ID>,DDD,MMM.MM,±WWW.WW,U,±CCC.CC,±TTT.TT,SS,[±1.1111,±2.2222,  
±3.3333±4.4444],<ETX>CC<CR><LF>

Where:

|          |   |   |
|----------|---|---|
| <STX>    | - | Start of string character (ASCII value 2)                     |
| <ID>     | - | Anemometer Identification (A-Z)                               |
| DDD      | - | Direction in degrees  |
| MMM.MM   | - | Wind Magnitude  |
| ±WWW.WW  | - | 'W' axis velocity 0.01ms <sup>-1</sup> units                  |
| U        | - | Units (M=m/s, N=knots, P=mph, K=kph)                          |
| ±CCC.CC  | - | Speed of Sound in 0.01ms <sup>-1</sup> units                  |
| ±TTT.TT  | - | Sonic Temperature in Degrees C.                               |
| SS       | - | Status data (Codes 00 to 0B)                                  |
| ±1.1111  | - | Analogue input 1 in volts                                     |
| ±2.2222  | - | Analogue input 2 in volts                                     |
| ±3.3333  | - | Analogue input 3 in volts                                     |
| ±4.4444  | - | Analogue input 4 in volts                                     |
| <ETX>    | - | End of string character (ASCII value 3)                       |
| CC       | - | Checksum of all Characters between <STX> and <ETX> (HEX byte) |
| <CR><LF> | - | Carriage Return and Line Feed                                 |

See also Polled Notes above.

#### 7.5. Mode 7 –Binary, Polar, Short

<B1><B1>STATUS,DIR,MAG,W,SOS,CHECKSUM

<B1> -

<B1> -

STATUS - Status data (Codes 00 to 10)

DIR Wind Direction

MAG Wind Speed

W W axis velocity

SOS Speed of Sound in 0.01ms

CHECKSUM

Notes:-

Data is 2 byte signed two's complement (except unsigned for SOS; 1 byte for checksum).

Velocities are normal resolution (0.01m/s).

Outputs that are disabled are padded with zero to give fixed size records.

Gill WinConvert now includes decode for WM binary data in addition to R3.

#### 7.6. Mode 8 –Binary, UVW, Short

<B2><B2>STATUS,U,V,W,SOS,CHECKSUM

<B2> -

<B2> -

STATUS - Status data (Codes 00 to 0B)

U U axis velocity

V V axis velocity

W W axis velocity

SOS Speed of Sound in 0.01ms<sup>-1</sup>

CHECKSUM

### 7.7. Mode 9 –Binary, Polar, Long

<B3><B3>STATUS,DIR,MAG,W,SOS,A1,A2,A3,A4,CHECKSUM

<B3> -

<B3> -

STATUS - Status data (Codes 00 to 0B)

DIR Wind Direction

MAG Wind Speed

W W axis velocity

SOS Speed of Sound in  $0.01\text{ms}^{-1}$

A1 Analogue input 1

A2 Analogue input 2

A3 Analogue input 3

A4 Analogue input 4

CHECKSUM

### 7.8. Mode 10 –Binary, UVW, Long

One record consists of 23 Bytes:-

0xB4 0xB4 StaL StaH Wc1L Wc1H Wc2L Wc2H Wc3L Wc3H SoSL SoSH A1L A1H A2L A2H A3L A3L A4H A4L Checksum

| Variable  | Description   | Byte  |
|-----------|---|-------|
| 0xB4 0xB4 | Start message identifier (HEX B4 = decimal 180)   | 1+2   |
| Sta       | Status data (Information only on low byte (Codes 00 to 0B), high byte always zero).     | 3+4   |
| Wc1       | U axis wind velocity (16 bit signed integer).   | 5+6   |
| Wc2       | V axis wind velocity (16 bit signed integer)  | 7+8   |
| Wc3       | W axis wind velocity (16 bit signed integer)  | 9+10  |
| SoS       | Speed of Sound in 0.01ms (16 bit signed integer)  | 11+12 |
| A1        | Analogue input 1 (16 bit signed integer).   | 13+14 |
| A2        | Analogue input 2 (16 bit signed integer).   | 15+16 |
| A3        | Analogue input 3 (16 bit signed integer).   | 17+18 |
| A4        | Analogue input 4 (16 bit signed integer).   | 19+20 |
| Checksum  | Checksum (exclusive OR of bytes between start of message identifier and checksum byte). | 23    |

SoS is always reported as Speed of Sound independent of A command setting.

A1 to A4 are always reported independent from the I command setting.

## 8. ANALOGUE INPUTS

Options for four analogue inputs with 14 bit resolution must be specified when ordering.

### 8.1. Analogue Inputs

The input range is fixed at  $\pm 5V$

For pin connections see 6.5 Connections.

The WindMaster HS can be configured for 4 single analogue inputs or 2 differential analogue inputs ((Pair 6 Brown and Pair 6 Black) and (Pair 7 Orange and Pair 7 Black)).

**Notes:** The Analogue inputs must be enabled if they are to be used, (See Section 10, Configuring).

**Analogue inputs are not supported in Syncpoll 1 mode (see page 7.**

|                         |                                |
|-------------------------|--------------------------------|
| Input range             | - 5 V to + 5 V                 |
| Common mode input range | $\pm 5 V$                      |
| Input impedance         | 310 K ohm in series with 2.5 V |
| Resolution              | 14 bit (as installed)          |

### 8.2. Input Rates

In single ended mode timing responses are:-

| Channel | 20Hz Base Rate | 32Hz Base Rate |
|---------|----------------|----------------|
| 1       | 20Hz           | 32Hz           |
| 2       | 20Hz           | 16Hz           |
| 3       | 5Hz            | 4Hz            |
| 4       | 5Hz            | 4Hz            |
| PRT     | 5Hz            | 4Hz            |

## 9. ANALOGUE OUTPUTS

Options for four analogue outputs with 14 bit resolution must be specified when ordering.

**Information on how to change the formats and all the settings follows in Section 10, CONFIGURING.**

### 9.1. Output allocations

Each of the outputs can be configured to one of the following:-

U, V, W, Polar Angle (Horizontal Direction), Speed of Sound, Sonic Temperature, Status, Polar magnitude (Horizontal Wind Speed).

### 9.2. Output types

They are user-configurable as:-

|         |               |                                   |
|---------|---------------|-----------------------------------|
| Voltage | 0V to 5V,     | or -2.5V to +2.5V, or -5V to +5V, |
| Current | 4mA to 20 mA, | or 0mA to 20mA.                   |

### 9.3. Voltage outputs

The output impedance is less than 1 ohm. To prevent inaccuracies, the outputs should be connected to an input with an impedance greater than 10K $\Omega$ .

## 9.4. Current outputs

### Important

When using the current outputs, the load resistance between the Output and Ground must be  $\leq 300$  ohms, including cable resistance.

*This is to ensure that the voltage levels on the Analogue outputs do not exceed 5V.*

### Scaling

#### UVW Wind Speed Output Scale Setting.

This is user-configurable to 5, 10, 20, 30, 40, 50, 60, or 120 m/s full scale for wind speed.

Using 50m/s and UVW setting as an example, this defines the outputs range as follows:-

| UVW Output | Voltage<br>0 to 5V | Voltage<br>$\pm 2.5V$ | Voltage<br>$\pm 5V$ | Current<br>4 - 20 mA | Current<br>0 - 20 mA |
|------------|--------------------|-----------------------|---------------------|----------------------|----------------------|
| -50 m/s    | 0                  | -2.5                  | -5                  | 4                    | 0                    |
| 0 m/s      | +2.5               | 0                     | 0                   | 12                   | 10                   |
| +50 m/s    | +5                 | +2.5                  | +5                  | 20                   | 20                   |

#### Polar and W Wind Speed Output Scale Setting.

This is user-configurable to 5, 10, 20, 30, 40, 50, 60, or 120 m/s full scale for wind speed.

Using 50m/s and Polar (+ W) setting as an example, this defines the outputs range as follows:-

| Polar Output | Voltage<br>0 to 5V | Voltage<br>$\pm 2.5V$ | Voltage<br>$\pm 5V$ | Current<br>4 - 20 mA | Current<br>0 - 20 mA |
|--------------|--------------------|-----------------------|---------------------|----------------------|----------------------|
| 0m/s         | 0                  | -2.5                  | -5                  | 4                    | 0                    |
| +50 m/s      | +5                 | +2.5                  | +5                  | 20                   | 20                   |

| W Output | Voltage<br>0 to 5V | Voltage<br>$\pm 2.5V$ | Voltage<br>$\pm 5V$ | Current<br>4 - 20 mA | Current<br>0 - 20 mA |
|----------|--------------------|-----------------------|---------------------|----------------------|----------------------|
| -50 m/s  | 0                  | -2.5                  | -5                  | 4                    | 0                    |
| 0 m/s    | +2.5               | 0                     | 0                   | 12                   | 10                   |
| +50 m/s  | +5                 | +2.5                  | +5                  | 20                   | 20                   |

### 9.5. Polar wind direction wraparound

The wind direction in Polar mode can be configured for either 360° or 540° Wraparound. If the 360° mode is used with a chart recorder, large swings of the recorder pen will be experienced each time the wind direction passes between 0 and 359°. Using the 540° mode, when the wind first changes from 0° to 359°, there will be a step change on the output, but after this first time the output will change smoothly each time the wind passes through 360°. (Similarly, the first time the wind veers from 539° to 180°, there will be a step change, after which the output will change smoothly).

NOTE: Values given for guidance, considering a clockwise spin in Wind Direction

| Output                 | Voltage<br>0 to 5V | Voltage<br>± 2.5V | Voltage<br>± 5.0V | Current<br>4 - 20 mA | Current<br>0 - 20 mA |
|------------------------|--------------------|-------------------|-------------------|----------------------|----------------------|
| <b>360°</b>            |                    |                   |                   |                      |                      |
| 0°                     | 0.00               | - 2.50            | -5.0              | 4.00                 | 0.00                 |
| 180°                   | 2.50               | 0.00              | 0                 | 12.00                | 10.00                |
| 359.9°                 | 5.00               | +2.50             | +5.0              | 20.00                | 20.00                |
| <b>540° wraparound</b> |                    |                   |                   |                      |                      |
| 0°                     | 0.00               | -2.50             | -5.0              | 4.00                 | 0.00                 |
| 180°                   | 1.67               | -0.83             | -1.66             | 9.33                 | 6.67                 |
| 360°                   | 3.33               | +0.83             | +1.66             | 14.67                | 13.33                |
| 539.9°                 | 5.00               | +2.50             | +5.0              | 20.00                | 20.00                |

### 9.6. Speed of Sound and Sonic Temperature

Scaling for Speed of Sound and Sonic Temperature is as follows:-

| Sonic Temp<br>(Deg C) | -40           | -30           | -20           | -10           | 0             | 10            | 20            | 30            | 40            | 50            | 60            | 70            |
|-----------------------|---------------|---------------|---------------|---------------|---------------|---------------|---------------|---------------|---------------|---------------|---------------|---------------|
| <b>SOS (m/s)</b>      | <b>300.00</b> | <b>306.36</b> | <b>312.73</b> | <b>319.09</b> | <b>325.45</b> | <b>331.82</b> | <b>338.18</b> | <b>344.55</b> | <b>350.91</b> | <b>357.27</b> | <b>363.64</b> | <b>370.00</b> |
| +/-5V                 | -5.00         | -4.09         | -3.18         | -2.27         | -1.36         | -0.45         | 0.45          | 1.36          | 2.27          | 3.18          | 4.09          | 5.00          |
| 0-5V                  | 0.00          | 0.45          | 0.91          | 1.36          | 1.82          | 2.27          | 2.73          | 3.18          | 3.64          | 4.09          | 4.55          | 5.00          |
| +/-2.5                | -2.50         | -2.05         | -1.59         | -1.14         | -0.68         | -0.23         | 0.23          | 0.68          | 1.14          | 1.59          | 2.05          | 2.50          |
| 4-20mA                | 4.00          | 5.45          | 6.91          | 8.36          | 9.82          | 11.27         | 12.73         | 14.18         | 15.64         | 17.09         | 18.55         | 20.00         |
| 0-20mA                | 0.00          | 1.82          | 3.64          | 5.45          | 7.27          | 9.09          | 10.91         | 12.73         | 14.55         | 16.36         | 18.18         | 20.00         |

### 9.7. Status

If an output is configured for Status reporting then example levels will be as follows for good signal high, bad (error) signal low depending on output type. High/Low table contents will be reversed if good signal low, bad signal high is used.

|                                |     |       |     |      |      |
|--------------------------------|-----|-------|-----|------|------|
| Good Signal status code (high) | +5V | +2.5V | +5v | 20mA | 20mA |
| Error Signal Status Code (low) | 0V  | -2.5V | -5V | 0mA  | 4mA  |

## 10. CONFIGURING

It is strongly recommended that **WIND** software (available free from the Gill website <http://www.gill.co.uk/main/software.html>) is used to configure the WindMaster HS.

A less preferred option for configuring is using a terminal emulation package, using command codes.

These are both described in the sections below.

**Note** Certain combinations of output rate, baud rate and message type may be unsupported.

### 10.1. WIND software

Download the **WIND** software from the Gill website <http://www.gill.co.uk/main/software.html>

Assuming the WindMaster HS has been correctly connected to the PC and a Power Supply, the opening menu will show the WindMaster HS in Measurement mode. A short Start message will be displayed, followed by continuous wind information displayed - the default setting being **Polar**, with the unit of measure **Metres per second** (m/s).

If a message similar to the one below is displayed, click **Tools** and **Synch Comms** in the tool bar and the system will be synchronised and correct data displayed.

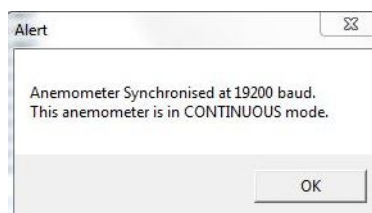

If after Synch Comms there is still a problem with start-up, switch power to anemometer off and then on again and repeat procedure.



The unit is set to factory default 1 Hz output and in Polar mode. A typical message format after Synchronising Comms is shown below:

WindMaster Pro 32Hz (SS) (HS) Gill Instruments Ltd

2329-504-01

RS232 (AUTO)

CHECKSUM ROM:978B 978B \*PASS\*

CHECKSUM FAC:0B19 0B19 \*PASS\*

CHECKSUM ENG:2C15 2C15 \*PASS\*

CHECKSUM CAL:FE41 FE41 \*PASS\*

Q,148,000.20,+000.71,M,00,0E

Q,241,000.16,+000.16,M,00,00

Q,187,000.06,+000.03,M,00,0C

If you need to review your instrument settings click **Tools** and **Report config** in the tool bar. When selected a similar message to that below will be displayed.

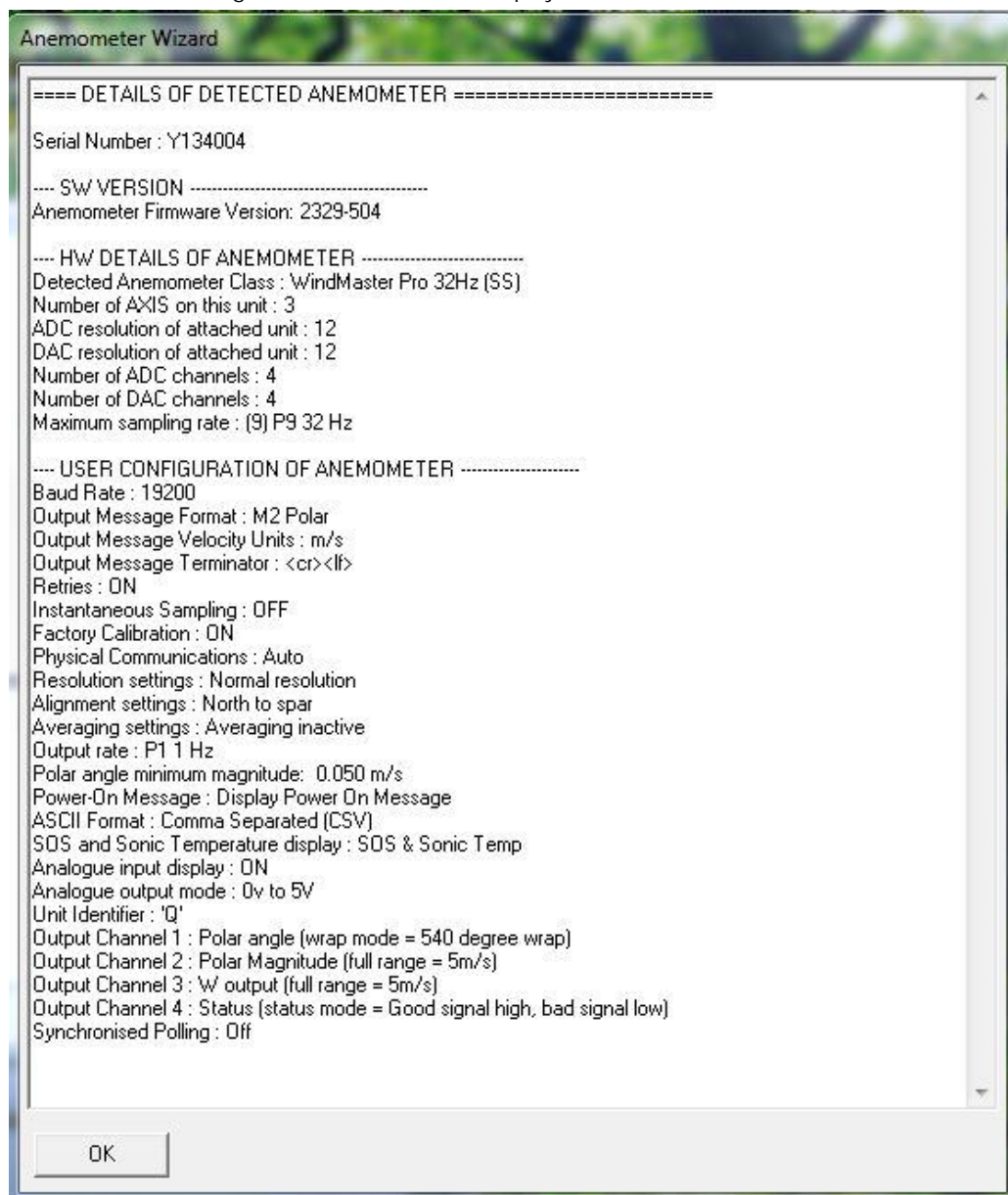

To change the WindMaster HS configuration click **Tools** and **Wizard** in the tool bar

Typical screens are shown below. The Customer is able to adjust all the settings as required taking into account the options selected at time of order (e.g. Analogue inputs and outputs).

**Anemometer Wizard**

|                       |          |
|-----------------------|----------|
| Message Output Format | M2 Polar |
| Baud Rate             | 19200    |
| Output Rate           | P1 1 Hz  |
| Message Terminator    | <cr><lf> |
| Measurement Units     | m/s      |

---

|                               |                   |
|-------------------------------|-------------------|
| Alignment                     | North to spar     |
| Averaging (0 = Off)           | 0                 |
| Resolution                    | Normal resolution |
| Direction Reporting Threshold | 50                |

(minimum magnitude for polar angle reporting)

**Anemometer Wizard**

|                         |                  |
|-------------------------|------------------|
| SOS/Sonic Temp Display  | SOS & Sonic Temp |
| Display Analogue Inputs | ON               |
| Analogue Output Mode    | 0v to 5V         |
| PRT setting             |                  |

---

|                  |   |
|------------------|---|
| Unit Identifier  | Q   |
| Power on Message | Display Power On Messag                                 |
|                  | <input checked="" type="checkbox"/> Retries Enabled     |
|                  | <input type="checkbox"/> Instantaneous Sampling         |
|                  | <input checked="" type="checkbox"/> Calibration Enabled |
| ASCII Format     | Comma Separated (CSV)                                   |

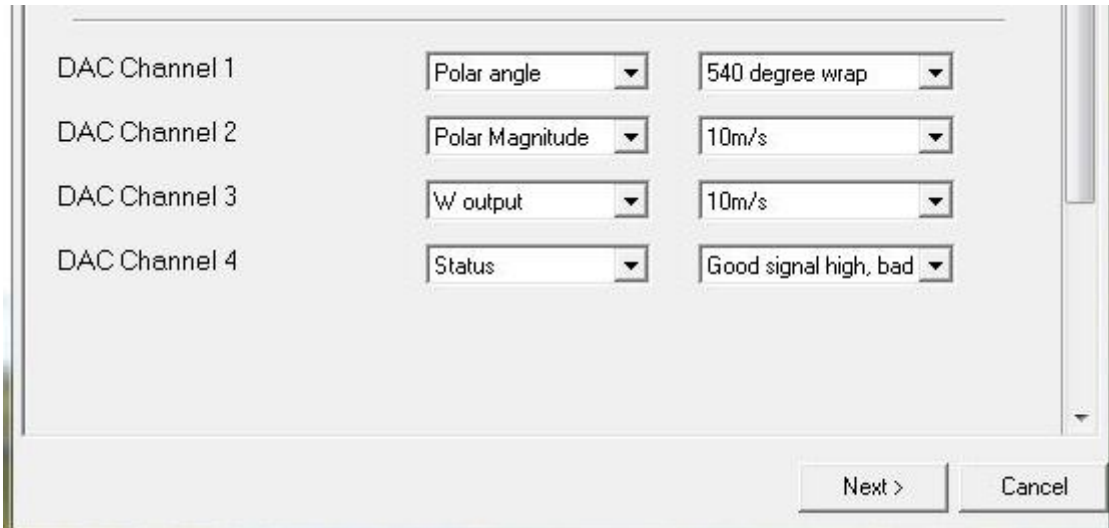

When the changes are complete the Wizard will display a confirmation of the changes with all changes shown in red, this may be printed as a hard copy if required. Click next and the WindMaster HS will be re-configured and will return to measurement mode.



## 10.2. Configuring using HyperTerminal

**Note** – Other terminal emulators can be used to configure the WindMaster HS in a very similar way.

### Setting up

1. Decide on an available Com port that you want to use (Usually Com1).
2. Run Hypertrm.exe (Typically accessed via Start → Programs → Accessories → Communications → Hyperterminal)
3. Create a New Connection (File → New Connection)
4. Enter a Name (eg WindMaster HS).
5. Change 'Connect Using' to 'Direct to Com 1' (or other Com port as required)
6. Adjust the Port settings to match WindMaster HS settings. WindMaster HS default settings are:

|                        |       |                                   |      |               |      |
|------------------------|-------|-----------------------------------|------|---------------|------|
| <b>Bits per second</b> | 19200 | <b>Data bits</b>                  | 8    | <b>Parity</b> | None |
| <b>Stop bits</b>       | 1     | <b>Flow Control</b> (Handshaking) | None |               |      |

Assuming the WindMaster HS has been correctly connected to the PC and a Power Supply; the opening menu will show the WindMaster HS in **Measurement mode** and scroll continuous wind information data.

### Entering Configuration mode

|                             |                                  |
|-----------------------------|----------------------------------|
| <b>From Continuous mode</b> | <input type="text" value="*"/>   |
| <b>From Polled mode</b>     | <input type="text" value="* N"/> |

where N is the Unit identifier (a letter between A and Z)

The WindMaster HS responds with a CONFIGURATION MODE message, stops reporting wind measurements, and waits for a command (as detailed below).

### Returning to Measurement mode

The WindMaster HS responds with wind measurements immediately when in Continuous mode, or on receipt of a Poll signal when in Polled mode.

This will be followed by a checksum test and then continuous wind information is displayed in the example as follows (polar, continuous, all options on).

RS232 (AUTO)

```
CHECKSUM ROM:978B 978B *PASS*
CHECKSUM FAC:0B05 0B05 *PASS*
CHECKSUM ENG:2C15 2C15 *PASS*
CHECKSUM CAL:1791 1791 *PASS*
```

```
Q,139,000.66,+000.94,M,+346.10,+024.23,00,+2.4225,+2.4200,+2.4225,+2.4225,01
Q,106,000.65,+000.67,M,+346.18,+024.37,00,+2.4225,+2.4200,+2.4225,+2.4225,0F
Q,097,000.38,+000.32,M,+346.20,+024.40,00,+2.4225,+2.4200,+2.4225,+2.4225,05
Q,108,000.34,+000.38,M,+346.31,+024.59,00,+2.4225,+2.4200,+2.4225,+2.4225,0C
Q,103,000.36,+000.44,M,+346.39,+024.73,00,+2.4225,+2.4200,+2.4225,+2.4225,0E
Q,113,000.27,+000.49,M,+346.37,+024.69,00,+2.4225,+2.4200,+2.4225,+2.4225,07
```

### Checking the configuration

We recommend that, as a standard procedure, you use this command prior to, and after, changing any settings. It shows the current settings for most of the alterable settings.

The WindMaster HS responds with the current default settings. These are shown below:

```
M2,U1,O1,L1,P1,B4,H1,NQ,E1,T1,S1,C2,A1,I1,J1,V1,X1,G0,K50
```

We suggest you note down the settings, so that you can easily return to them.

Return to measurement mode

Settings and how to change them are explained in the following section.

### Changing settings

To change a setting, refer to the sections below, and enter the command of the new setting required, followed by **ENTER**. If successful, the new setting will be sent back as a message by the WindMaster HS.

For example, to change the message format to UWW, Continuous, enter **M 1 ENTER**

The WindMaster HS will reply **M1**. When the unit is returned to the Measurement mode, it will be in UWW, Continuous format.

**Note :** The factory-set (default) settings are shown in bold in the following sections.

### Command List

| COMMAND | USER                                     |
|---------|--|
| A       | <b>SOS/Sonic Temp Output</b>             |
| B       | <b>Baud rate</b>                         |
| C       | <b>Analogue angle wrapping</b>           |
| D       | <b>Diagnostic / Config info</b>          |
| E       | <b>Set Physical Comms</b>                |
| F       | <b>Signal Processing</b>                 |
| G       | <b>Averaging Settings</b>                |
| H       | <b>Power on message</b>                  |
| I       | <b>Disable/Enable analogue input</b>     |
| J       | <b>High/Low Resolution</b>               |
| K       | <b>Minimum Direction Velocity</b>        |
| L       | <b>Message Terminator</b>                |
| M       | <b>Message Format</b>                    |
| N       | <b>Set Unit ID</b>                       |
| O       | <b>Set ASCII format</b>                  |
| P       | <b>Set output rate</b>                   |
| Q       | <b>MEASUREMENT MODE</b>                  |
| R       | <b>Not used</b>                          |
| S       | <b>Analogue output range</b>             |
| T       | <b>Analogue output type &amp; Config</b> |
| U       | <b>Select Units</b>                      |
| V       | <b>Not Used</b>                          |
| W       | <b>Not Used</b>                          |
| X       | <b>Axis Alignment</b>                    |
| Y       | <b>Not Used</b>                          |
| Z       | <b>Not used</b>                          |
| *       | <b>INTERACTIVE MODE</b>                  |

Where the command is a single parameter command the notation is Dx, for example if the parameter x = 2 then in interactive mode the user would type "D2".

Where the Command is dual parameter e.g. Fx y, then x selects the parameter and y turns it on or off (Fx<space>y). Typing just the command letter will cause the current settings to be output.

Warning: Certain combinations of output rate, baud rate and message type may be unsupported.

### Ax – Select SOS/Sonic Temp output

- |   |                |
|---|----------------|
| 1 | <b>Neither</b> |
| 2 | SOS            |
| 3 | Sonic Temp     |
| 4 | Both           |

The SOS and/or Sonic Temp are displayed after the UNITS and before the status byte, the SOS is always in m/s and the Sonic Temp is always in deg C.

### Bx – Set Baud rate

- |   |              |
|---|--------------|
| 1 | 2400         |
| 2 | 4800         |
| 3 | 9600         |
| 4 | <b>19200</b> |
| 5 | 38400        |
| 6 | 57600        |

If a request is sent to change the Baud rate, before it changes it must be confirmed by entering **B** **ENTER** at the new Baud rate.

eg. If set to B3 (9600 baud), to change to B5 (38400 baud), enter **B** **B** **ENTER**, change host terminal to 38400 baud, and confirm by entering **B** **ENTER**.

NOTE: a random echo may be generated after the B5 confirmation

Certain combinations of output rate, baud rate and message type may be unsupported.

### Cx – Analogue output polar direction wrapping

- |   |   |
|---|---|
| 1 | 540 degree wraparound on analogue output        |
| 2 | <b>360 degree wraparound on analogue output</b> |

### Dx – Diagnostic and configuration information

- |   |                                  |
|---|----------------------------------|
| 1 | Request serial number            |
| 2 | Request SW version               |
| 3 | Request current configuration    |
| 4 | -                                |
| 5 | -                                |
| 6 | -                                |
| 7 | Report DAC channel configuration |

Examples of Diagnostic information are as follows:

Request Serial Number

D1

Y134004

Request SW Version

D2

2329-504

Request Current Configuration

D3

M2,U1,O1,L1,P1,B4,H1,NQ,E1,T1,S1,C2,A1,I1,J1,V1,X1,G0,K50

Report DAC Channel Configuration.

D7

DAC CHAN 01, MODE 05, CONFIG 02

DAC CHAN 02, MODE 09, CONFIG 01

DAC CHAN 03, MODE 04, CONFIG 01

DAC CHAN 04, MODE 08, CONFIG 01

Where:-

Mode 01 = DAC Channel Off.

Mode 02 = U Magnitude Output.

Mode 03 = V Magnitude Output.

Mode 04 = W Magnitude Output.

Mode 05 = Polar Angle Output.

Mode 08 = Status (Good/Bad).

Mode 09 = Polar Magnitude Output.

and Configuration code for Mode 08 equates to good/bad status setting.

Config 01 = Good is high output level, Bad is low level.

Config 02 = Good is low output level, Bad is high level.

and Configuration codes for Modes 02, 03, 04, and 09 equate to scale setting:-

Config 01 = 5m/s

to

Config 08 = 120m/s

and Configuration code for Mode 5 equates to angle wrapping where:-

Config 01 = 540 degree wraparound.

Config 02 = 360 degree wraparound.

### Ex Set Physical Communications

|   |      |
|---|------|
| 1 | AUTO |
| 2 | 485  |
| 3 | 232  |

It is recommended to leave the unit in AUTO mode. This can also be overridden from RS232 to RS422/485 by linking the comms line to V+ for RS232 or to 0V for RS422/485. See section 6.5 to 6.9.

If a unit is set for E3 and required to be set back to E1 then with a HyperTerminal connection established go into Configuration Mode, Type E1 and Press Enter. Then Type E and Press Enter. Type Q and press Enter to go back into measurement mode.

### Fx y Signal Processing

| Signal                            | x        | Space | y        |
|-----------------------------------|----------|-------|----------|
| Retries Off                       | 1        |       | 0        |
| <b>Retries On</b>                 | <b>1</b> |       | <b>1</b> |
| <b>Instantaneous Sampling Off</b> | <b>2</b> |       | <b>0</b> |
| Instantaneous Sampling On         | 2        |       | 1        |
| Calibration Off                   | 3        |       | 0        |
| <b>Calibration On</b>             | <b>3</b> |       | <b>1</b> |



## Gx to Gxxxx – Not Aplicable

## Hx – Enable/Disable power on message

- |          |                                 |
|----------|---------------------------------|
| <b>1</b> | <b>Power on message enabled</b> |
| 2        | Power on message disabled       |

If the power up message is On, then a message similar to that below is output, whenever the unit goes into Measurement mode (i.e. when power is first applied to the unit, or the unit returns to Measurement mode from Configuration mode).

WindMaster HS Pro 32Hz (SS) Gill Instruments Ltd

2329-504-01

RS232 (AUTO)

CHECKSUM ROM:978B 978B \*PASS\*

CHECKSUM FAC:0B19 0B19 \*PASS\*

CHECKSUM ENG:2C15 2C15 \*PASS\*

CHECKSUM CAL:FE41 FE41 \*PASS\*

If any of these checksums fail, the word PASS will be replaced by FAIL and the unit will use its default settings. If the checksum repeatedly fails after power on – contact your supplier.

## Ix – Enable/Disable analogue input message

- |          |   |
|----------|---|
| <b>0</b> | <b>Analogue input data off</b>                    |
| 1        | Analogue input data on                            |
| 2        | Analogue inputs set for 2 Differential Mode pairs |

## Jx – Set the unit Resolution

- |          |   |
|----------|---|
| <b>1</b> | <b>Select Normal Resolution</b> (UVW, 2 decimal point readings) |
| 2        | Select High Resolution (UVW, 3 decimal point readings)          |

J2 High resolution is applicable to Wind Speed and Wind direction for Metres/sec setting only.

## Kxx to Kxxxx Set Minimum direction velocity

This allows the minimum wind velocity to be set at which display of the direction is enabled in thousandth of a metre per second. The default is 50, which means that any wind magnitude <0.05m/s will have the wind direction omitted in polar mode. The maximum value allowed for this is 5000, or 5m/s.

- |           |   |
|-----------|---|
| <b>50</b> | <b>Minimum direction velocity</b>                     |
| 0 to 5000 | Select minimum direction velocity (in 0.001m/s steps) |

## Lx – Message Terminator

- |          |                             |
|----------|-----------------------------|
| <b>1</b> | <b>&lt;CR&gt;&lt;LF&gt;</b> |
| 2        | <CR>                        |



## Mx – Message Format

- |     |                      |
|-----|----------------------|
| 1   | UWV                  |
| 2   | <b>Polar</b>         |
| 3   | UWV Polled           |
| 3 1 | UWV Sync Polled      |
| 4   | Polar Polled         |
| 7   | Binary, Polar, Short |
| 8   | Binary, UWV, Short   |
| 9   | Binary, Polar, Long  |
| 10  | Binary, UWV, Long    |

## Nx – Set unit ID

Sets the unit ID displayed at the start of all GILL communications strings

Set **Q (default)**, ... from A to Z      Command N<Q>

## Ox – Set ASCII output format

- |   |  |
|---|--|
| 1 | <b>Comma Separated Variable (CSV) format</b> |
| 2 | Fixed field                                  |

Example string for CSV data changing to an error status code condition.

```

00, ,000.02, -000.02, M, +346.57, +025.04, 00, +2.4225, +2.4200, +2.4225, +2.4225, #36
00, 026, 000.07, +000.03, M, +346.53, +024.97, 00, +2.4225, +2.4225, +2.4225, #08
00, , , M, , , 07, +2.4225, +2.4200, +2.4225, +2.4225, #1C
00, , , M, , , 07, +2.4200, +2.4200, +2.4225, +2.4225, #1B

```

Example string for Fixed Field data changing to an error status code condition.

```

00, 203, 000.14, +000.09, M, +346.16, +024.33, 00, +2.4225, +2.4200, +2.4225, +2.4225, #0D
00, 139, 000.12, +000.02, M, +346.69, +025.24, 00, +2.4250, +2.4200, +2.4225, +2.4225, #07
00, 999, 999.99, +999.99, M, +999.99, +999.99, 07, +2.4250, +2.4200, +2.4225, +2.4225, #0C
00, 999, 999.99, +999.99, M, +999.99, +999.99, 07, +2.4250, +2.4200, +2.4225, +2.4225, #0C

```

## Px – Set output rate

Note: the P9 setting is an option on the WindMaster HS unit, which must be specified at the time of ordering.

- |    |                                     |
|----|-------------------------------------|
| 1  | <b>Rate is 1 Hz (20Hz Sampling)</b> |
| 2  | Rate is 2 Hz (20Hz Sampling)        |
| 3  | Rate is 4 Hz (20Hz Sampling)        |
| 4  | Rate is 5 Hz (20Hz Sampling)        |
| 5  | Rate is 8 Hz (32Hz Sampling)        |
| 6  | Rate is 10 Hz (20Hz Sampling)       |
| 7  | Rate is 16 Hz (32Hz Sampling)       |
| 8  | Rate is 20 Hz (20Hz Sampling)       |
| 9  | Rate is 32 Hz (32Hz Sampling)       |
| 20 | Rate is ¼ Hz                        |
| 21 | Rate is ½ Hz                        |

### Sx – Analogue output range

This sets the velocity scaling for the analogue output. (see also Para 9.5).

- |          |                           |
|----------|---------------------------|
| <b>1</b> | <b>Full range is 5m/s</b> |
| 2        | Full range is 10m/s       |
| 3        | Full range is 20m/s       |
| 4        | Full range is 30m/s       |
| 5        | Full range is 40m/s       |
| 6        | Full range is 50m/s       |
| 7        | Full range is 60m/s       |
| 8        | Full range is 120m/s      |

### Tx – Set analogue output type

Use Gill Wind Software to set required ranges

- |          |                       |
|----------|-----------------------|
| <b>1</b> | <b>0V to 5V range</b> |
| 2        | -2.5V to 2.5V range   |
| 3        | 4mA to 20mA range     |
| 4        | -5V to 5V range       |
| 5        | 0mA to 20mA range     |

### Ux – Set units

- |          |            |
|----------|------------|
| <b>1</b> | <b>m/s</b> |
| 2        | Knots      |
| 3        | MPH        |
| 4        | KPH        |
| 5        | FPM        |

### Vx – Not Applicable

### Xx – Axis Alignment

- |          |   |
|----------|---|
| <b>1</b> | <b>Align U Axis to unit Frame (See Fig 2).</b>    |
| 2        | Align U to the top axis transducer 1              |
| 3        | Same as X1 but inverted for upside down operation |
| 4        | Same as X2 but inverted for upside down operation |

### 10.3. Viewing and logging WindMaster Data using Gill WindView Software.

WindView is supplied on the equipment CD but can also be downloaded from:-

<http://gillinstruments.com/main/software.html>

Open WindView and Select File/Connect.

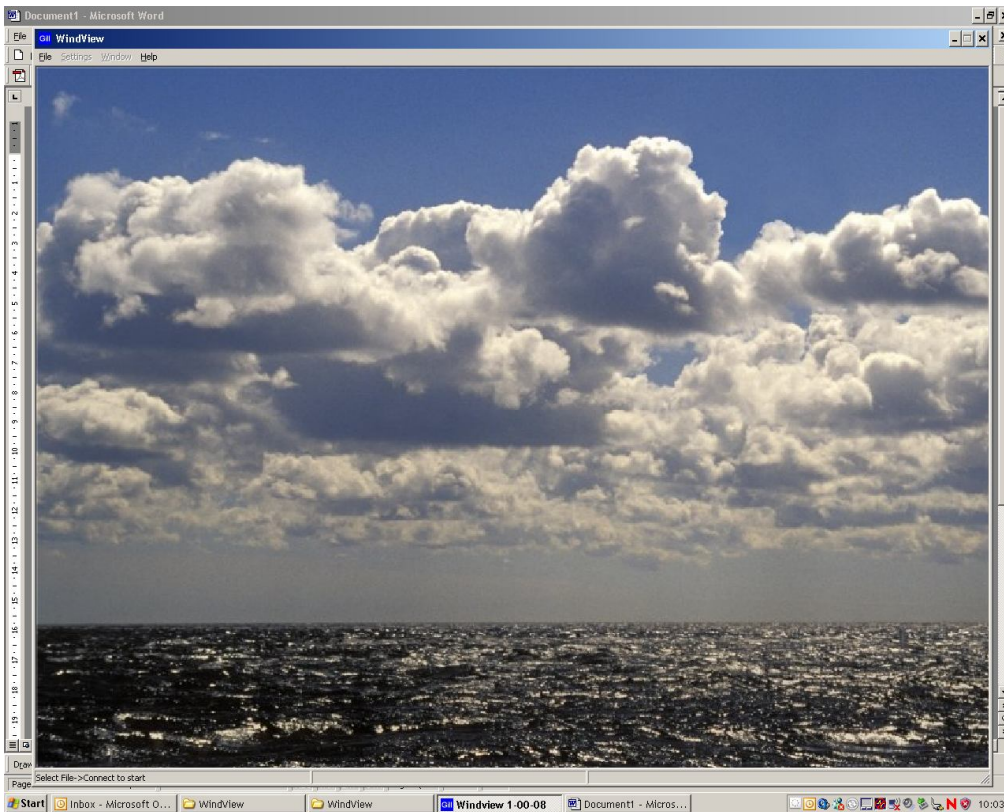

Select appropriate connection COM Port number and instrument Baud rate.

Select output format UV or Polar to match the WindMaster setting.

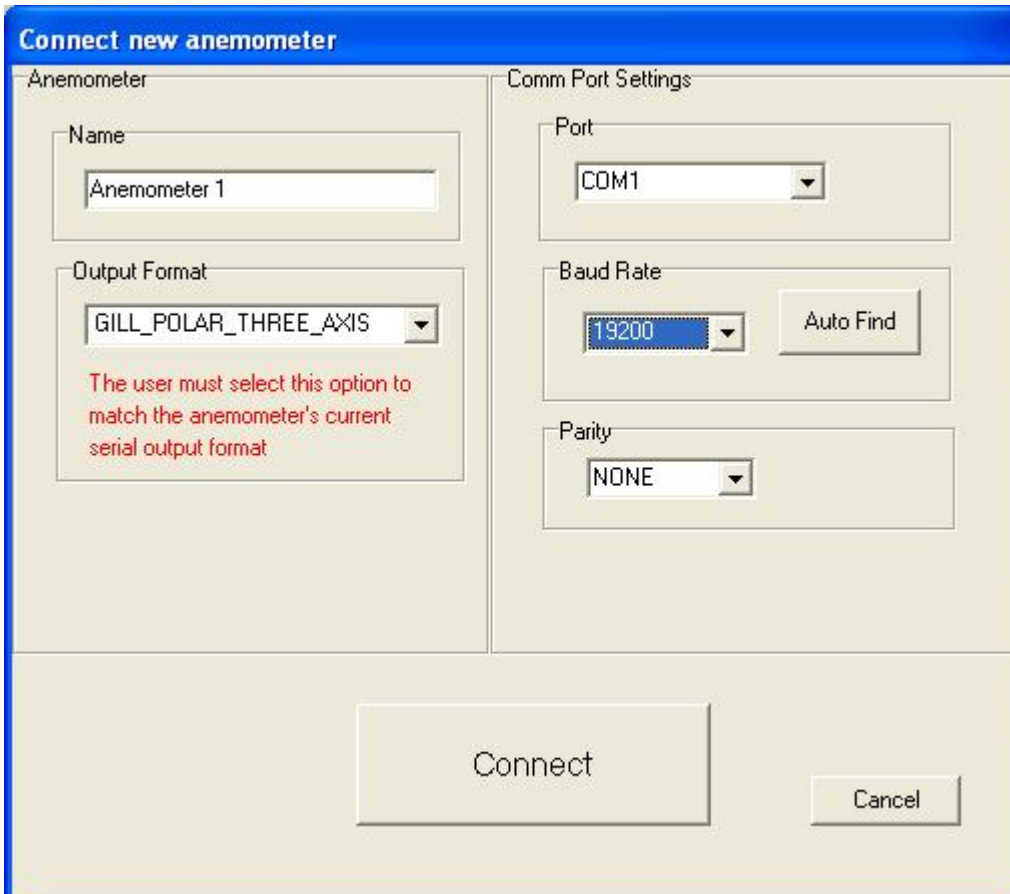

WindMaster 3 axis data will scroll on screen at the instruments output rate (2Hz shown).

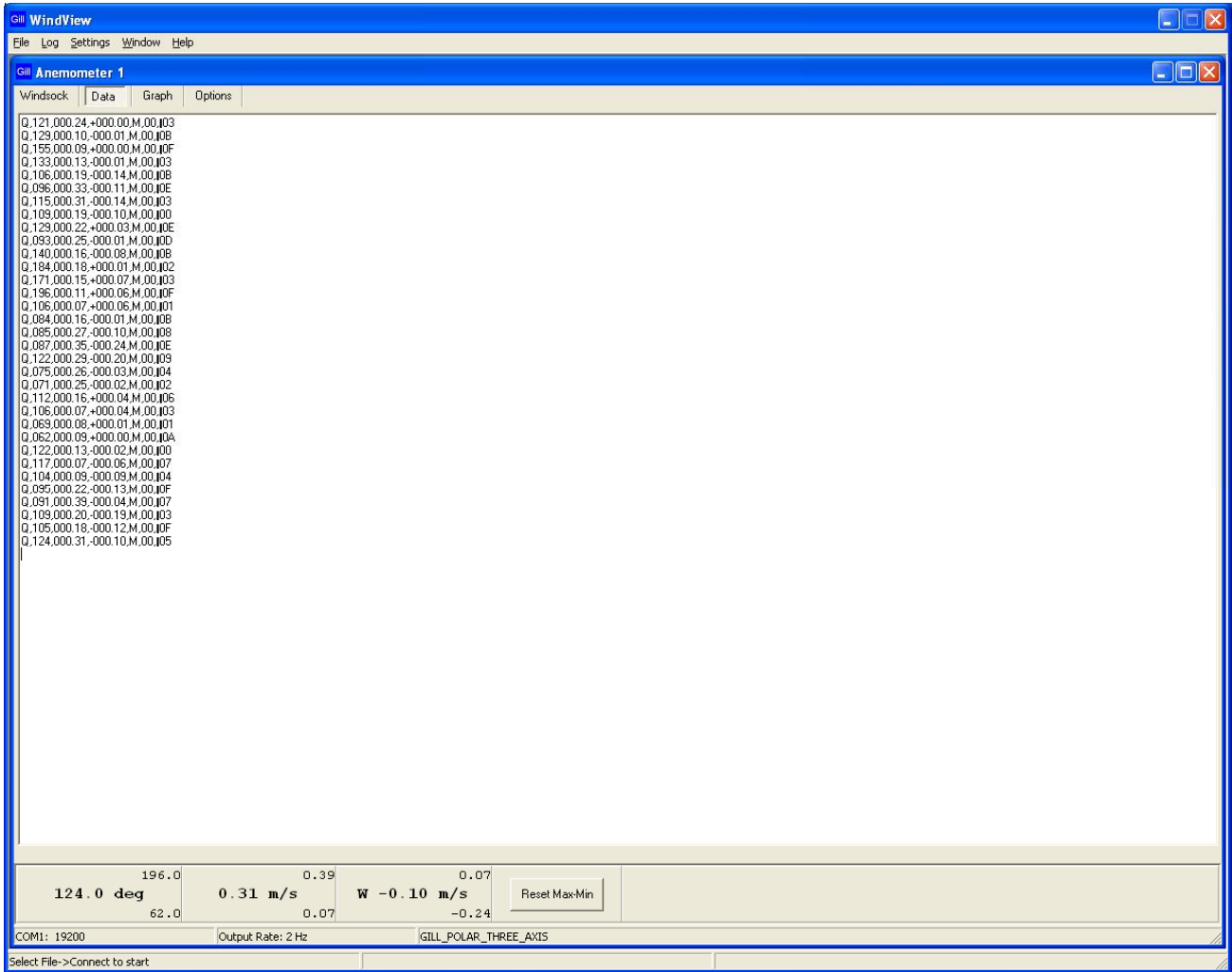

Click on the WindSock tab to see a graphical display of wind.

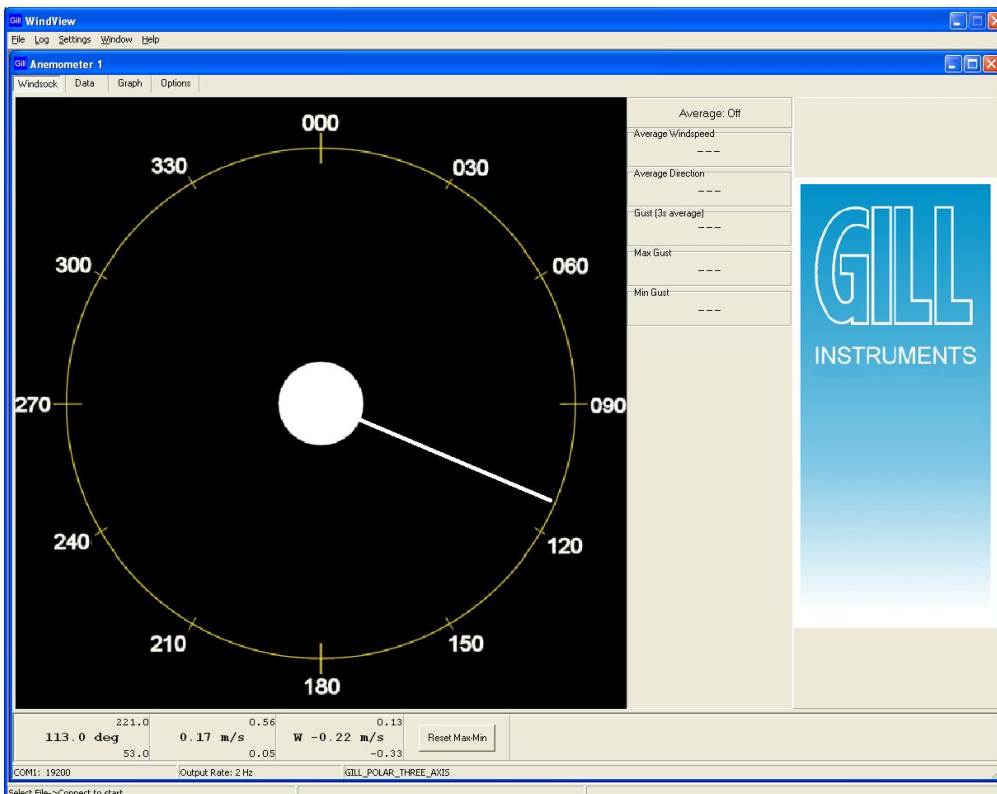

### To Start Logging Data

Note: If logging fast data of 20Hz or more ensure that the WindMaster is set for at least 38400 bauds.

From the top menu click on Settings/Logging.

If segmented logging files are required tick Enable and set the time for creating each log file.

Append Time stamp/Append record count as required

A free text field is available for logging comments.

Select a file directory and Name

Click on Apply.

Follow Note instruction to start logging on the top Menu Select File/Log/Start.

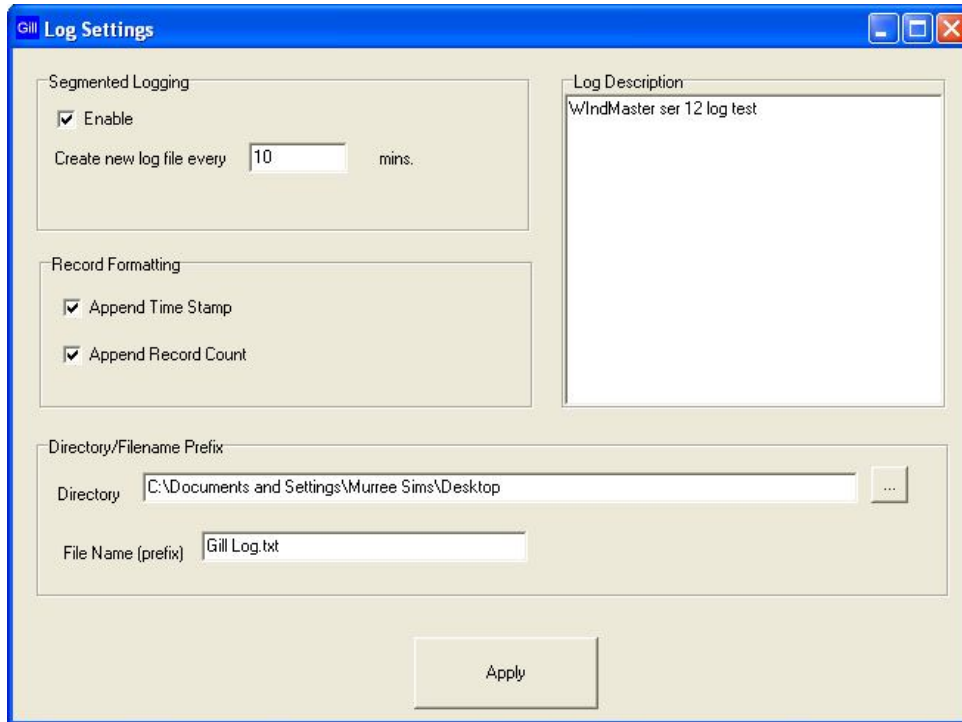

### To Stop Logging Data

When logging is required to stop go to the Top menu, Select File/Log/Stop.

A typical logged Notepad file is as follows (WindMaster set for 2Hz output rate):-

```
Gill Log [Anemometer 1]-1.txt - Notepad
File Edit Format View Help
windview - [Anemometer 1] Log File
WIndMaster ser 12 log test
Name: Anemometer 1
Output Format: GILL_POLAR_THREE_AXIS
Log file opened: 07/05/2010 15:42:17

Q,050,000.28,-000.21,M,00,00D,1,07/05/2010 15:42:18
Q,088,000.43,-000.19,M,00,00E,2,07/05/2010 15:42:18
Q,123,000.37,-000.13,M,00,007,3,07/05/2010 15:42:19
Q,121,000.32,-000.15,M,00,006,4,07/05/2010 15:42:19
Q,087,000.30,-000.19,M,00,005,5,07/05/2010 15:42:20
Q,099,000.38,-000.23,M,00,00B,6,07/05/2010 15:42:20
Q,109,000.32,-000.10,M,00,009,7,07/05/2010 15:42:21
Q,143,000.30,-000.07,M,00,003,8,07/05/2010 15:42:21
Q,149,000.24,-000.07,M,00,00C,9,07/05/2010 15:42:22
Q,155,000.20,-000.06,M,00,004,10,07/05/2010 15:42:22
Q,182,000.16,-000.14,M,00,008,11,07/05/2010 15:42:23
Q,190,000.16,-000.11,M,00,00E,12,07/05/2010 15:42:23
Q,172,000.06,-000.12,M,00,000,13,07/05/2010 15:42:24
Q,246,000.07,-000.06,M,00,000,14,07/05/2010 15:42:24
Q,219,000.17,-000.01,M,00,00C,15,07/05/2010 15:42:25
Q,202,000.16,+000.04,M,00,004,16,07/05/2010 15:42:25
Q,245,000.05,+000.03,M,00,002,17,07/05/2010 15:42:26
Q,193,000.13,+000.12,M,00,00D,18,07/05/2010 15:42:26
Q,181,000.26,-000.03,M,00,00E,19,07/05/2010 15:42:27
Q,152,000.06,-000.12,M,00,002,20,07/05/2010 15:42:27
Q,065,000.10,-000.21,M,00,000,21,07/05/2010 15:42:28
Q,249,000.12,-000.12,M,00,00E,22,07/05/2010 15:42:28
Q,223,000.17,-000.04,M,00,000,23,07/05/2010 15:42:29
Q,241,000.20,+000.03,M,00,001,24,07/05/2010 15:42:29
Q,244,000.19,+000.02,M,00,00F,25,07/05/2010 15:42:30
Q,227,000.16,+000.01,M,00,006,26,07/05/2010 15:42:30
```

## 11. MAINTENANCE & FAULT-FINDING

### 11.1. Cleaning

If there is any build-up of deposit on the unit, it should be gently cleaned with a cloth moistened with water and soft detergent. Solvents should not be used, and care should be taken to avoid scratching any surfaces. The unit must be allowed to defrost naturally after being exposed to snow or icy conditions, do NOT attempt to remove ice or snow with a tool.

### 11.2. Servicing

There are no moving parts or user-serviceable parts requiring routine maintenance.

Opening the unit or breaking the security seal will void the warranty and the calibration.

In the event of failure, prior to returning the unit to your authorised Gill distributor, it is recommended that:

1. All cables and connectors are checked for continuity, bad contacts, corrosion etc.
2. A bench test is carried out as described in Section 12.1.
3. You contact your supplier for advice

### 11.3. Fault-finding

| Symptom  | Solution   |
|--|--|
| No output  | Check DC power to WindMaster HS, cable and connections.<br>Check Comms settings of WindMaster HS ( <i>as detailed in Section 10</i> ) and host system match, including correct Com port. Try using Gill Wind Software/Tools/Synch Comms<br>Check unit is in Continuous mode<br>Check that in-line communication devices are wired correctly.<br>NOTE: It is usual for Anemometer TX to be connected to converter device RX |
| Corrupted output   | Check Comms settings of WindMaster HS and host system match.<br>Try using Gill Wind Software/Tools/Synch Comms<br>Try a slower baud rate.<br>Check cable lengths and type of cable.  |
| One way communication                                      | Check WindMaster HS and host system are both set to the same protocol RS232, RS422, or RS485.<br>Check wiring is in accordance with the manual.  |
| Failed / Incorrect WindMaster HS output, data invalid flag | Check that transducer path is not blocked  |

### 11.4. Status (error) codes

The Status code is sent as part of each wind measurement message.

| Code | Status                 | Condition  |
|------|------------------------|--|
| 00   | OK                     | Functioning correctly  |
| 01   | Sample failure         | Insufficient samples in average period from transducer pair 1    |
| 02   | Sample Failure         | Insufficient samples in average period from transducer pair 2    |
| 03   | Sample Failure         | Insufficient samples in average period from transducer pair 3    |
| 04   | Sample Failure         | Insufficient samples in average period from transducer pairs 1,2 |
| 05   | Sample Failure         | Insufficient samples in average period from transducer pairs 1,3 |
| 06   | Sample Failure         | Insufficient samples in average period from transducer pairs 2,3 |
| 07   | Sample Failure         | Insufficient samples in average period from all transducer pairs |
| 08   | NVM Error              | NVM Checksum failed  |
| 09   | ROM Error              | ROM checksum failed  |
| 0A   | System gain at Maximum | Results OK, but marginal operation                               |
| 0B   | Retries                | Retries used   |



## 11.5. Returning unit

If the unit has to be returned, it should be carefully packed in the original packaging and returned to your authorised Gill distributor, with a full description of the fault condition.

## 12. TESTS

### 12.1. Bench test

1. Couple the WindMaster HS to the host system and power supply, using a known working test cable.
2. Check that the unit is correctly configured (*see Section 10*).
3. Check for normal output data, and that the Status Code is OK – 00.
4. If the status code is other than 00 or 0A, refer to Section 11.4 Status (error) codes.
5. Use an office fan or similar to check that the unit is sensing wind, turning the unit to simulate changing wind direction and to check that all three axes are functioning.
6. Note that this is a quick functional test. There are no calibration adjustments. *See 12.2.*

*Note: Refer to Dx – diagnostic and configuration information for further self-tests*

### 12.2. Calibration

**Note** - There are no in-use calibration adjustments; the unit is designed NOT to require re-calibration within its lifetime.

#### Standard calibration

|                    |                     |              |
|--------------------|---------------------|--------------|
| Accuracy at 12 m/s | Wind speed 1.5% RMS | Direction 2° |
|--------------------|---------------------|--------------|

#### Certified calibration

The unit can be Wind tunnel calibrated in accordance with ISO 16622 with traceability to national standards. This should be specified when ordering, or the unit can be returned to Gill Instruments for retrospective calibration.

|                    |                   |                |
|--------------------|-------------------|----------------|
| Accuracy at 12 m/s | Wind speed 1% RMS | Direction 0.5° |
|--------------------|-------------------|----------------|

## 13. APPENDICES

### 13.1. Guarantee

For terms of guarantee contact your supplier.

Warranty is void if the red security seal covering base nuts is damaged or broken, or the transducer caps have been damaged.

## 13.2. Electrical Conformity

### EU Declaration of Conformity

---

We  
Of

**Gill Instruments Limited**  
**Saltmarsh Park**  
**67 Gosport Street**  
**Lymington**  
**SO41 9EG**  
**England**



In accordance with the following CE Directives:



**2014-30-EU (Electromagnetic Compliance - EMC)**  
**2011-65-EU (Restriction of Hazardous Substances - RoHS)**

Hereby declare under our sole responsibility that the following products have been designed and where appropriate, manufactured and tested in accordance with the applicable requirements of the following European harmonised standards and where applicable, IEC Standards:

#### 1951 WindMaster HS Anemometer

|                                     |  |
|-------------------------------------|--|
| EMC Emissions & Immunity            | <b>EN60945:2002</b><br><b>EN61326-1:2013</b> |
| Restriction of Hazardous Substances | <b>EN50581:2012</b>                          |

Signed by:



Print Name:

**R. McKay**

Position:

**Product Manager**

Date of Issue:

**14<sup>th</sup> February 2017**

Place of Issue:

**Gill Instruments Ltd, Lymington**