

Rugged TROLL[®] 100 and 200 and Rugged BaroTROLL Instruments



Copyright © 2013 by In-Situ All rights reserved.

This document contains proprietary information which is protected by copyright. No part of this document may be photocopied, reproduced, or translated to another language without the prior written consent of In-Situ

Mailing and Shipping

Address:

In-Situ
221 East Lincoln Avenue
Fort Collins, CO 80524-2533
U.S.A.

Phone: 970-498-1500 (international & domestic)

Fax: 970-498-1598

Internet: www.in-situ.com

Support: 800-446-7488 (U.S.A. & Canada)

In-Situ makes no warranty of any kind with regard to this material, including, but not limited to, its fitness for a particular application. In-Situ will not be liable for errors contained herein or for incidental or consequential damages in connection with the furnishing, performance, or use of this material.

In no event shall In-Situ Inc. be liable for any claim for direct, incidental, or consequential damages arising out of, or in connection with, the sale, manufacture, delivery, or use of any product.

In-Situ and the In-Situ logo, Win-Situ, TROLL, Baro Merge, BaroTROLL, HERMIT, HydroVu™, iSitu, Pocket-Situ, RDO, RuggedCable, RuggedReader, SmarTROLL™, TROLL, VuSitu™, and Win-Situ are trademarks or registered trademarks of In-Situ Inc. Microsoft and Windows are registered trademarks of Microsoft Corporation. Pentium is a registered trademark of Intel. Tefzel and Delrin are registered trademarks of E. I. DuPont de Nemours and Company. Viton is a registered trademark of DuPont Dow Elastomers. Kellems is a registered trademark of Hubbell Inc. Alconox is a registered trademark of Alconox Company. Lime-A-Way is a registered trademark of Reckitt Benckiser. Android is a trademark of Google Inc. iPod and iPhone are trademarks of Apple Inc., registered in the U.S. and other countries. The Bluetooth word mark and logos are registered trademarks owned by the Bluetooth SIG, Inc. and any use of such marks by In-Situ Inc. is under license. NIST is a registered trademark of the National Institute of Standards and Technology, U.S.A. Other brand names and trademarks are property of their respective owners.



The presence of the Waste Electrical and Electronic Equipment (WEEE) marking on the product indicates that the device is not to be disposed via the municipal waste collection system of any member state of the European Union.

For products under the requirement of WEEE directive, please contact your distributor or local In-Situ office for the proper decontamination information and take back program, which will facilitate the proper collection, treatment, recovery, recycling, and safe disposal of the device.

0092440 | Rev. 001

Table of Contents

1 Table of Contents	3
2 Introduction	5
Scope	5
Serial Number Location	5
Certification	5
Unpacking and Inspection	5
Warranty	5
Contact Information	5
3 Product Specifications	6
Rugged TROLL 100 and 200 Specifications	6
Rugged BaroTROLL Specifications	7
4 Overview	8
Rugged TROLL Overview	8
Rugged BaroTROLL Overview	8
Communication Accessories	9
Other Accessories	9
Equipment Configuration Table	10
5 Getting Started	11
Install Software	11
Win-Situ 5 Software	11
Win-Situ Baro Merge Software	11
About VuSitu	11
Verify the VuSitu Mobile App Version	11
Connecting Your Instrument to VuSitu	12
VuSitu Menu Options	12
Menu Options when Connected to Instrument	12
Taking live readings in VuSitu	13
Downloading and sharing your data.	13
Connect to the Rugged TROLL Docking Station	15
Connect to the Rugged TROLL Com	15
Rugged TROLL Com Battery Installation	16
Connections	16
Deploying the Instruments	17
Rugged TROLL 200 Cable Suspension	18
Wiring Connections for Stripped-and-Tinned Cable	19
SDI-12 Connections	19
RS485 Connections	20
6 Win-Situ Overview	22
Data Tab	22
Home Tab	24

Logging Tab	27
Sensors Tab	29
Device Setup Tab	29
7 Using Win-Situ 5 Software	31
Connecting an Instrument to the Software	31
Selecting the Correct COM Port	31
Bluetooth & Wireless TROLL Com	32
Setting the Instrument Time	32
Adding a New Site	33
Log Setup	33
Logging Method Descriptions	33
Logging Methods for Long-Term Monitoring	34
Linear	34
Linear Average	34
Event	34
About the Level Reference	34
Starting a Log	35
Starting a Pending Log	35
Starting a Manual Log	35
Suspending (Pausing) a Log	35
Resuming a Suspended Log	35
Stopping a Log	35
Downloading Data to a PC	36
Viewing Logged Data	36
Importing VuSitu Data to Win-Situ	36
Using BaroMerge Software	38
Baro Merge Input—Fixed Correction	39
Baro Merge Input—Manual Entry	40
BaroMerge Output	41
Disconnecting an Instrument from the Software	41
8 Maintenance, Cleaning, and Storage	42
O-ring Inspection and Replacement	42
Cleaning the Instrument	42
Storage	43
9 Service	44
Return Materials Authorization (RMA) Form	44
Obtaining Repair Service	44
Guidelines for Cleaning Returned Equipment	45
10 Decontamination and Cleaning Form	46
11 Declarations of Conformity and Similarity	47

Introduction

The Rugged TROLL Instrument is a compact, modular system for measuring level and temperature in natural groundwater, surface water, industrial waters, and other installations.

Scope

This document is intended to describe the characteristics, operation, calibration, and maintenance of the instrument. Communication registers and SDI-12 programming information can be found in the Modbus and SDI-12 Reference Guides on the In-Situ website.

Serial Number Location

The serial number is engraved on the instrument housing. It is also programmed into the instrument and is displayed when the instrument is connected to a computer running Win-Situ Software.

Certification

See the Declarations of conformity at end of this manual.

Unpacking and Inspection

Your instrument was carefully inspected before shipping. Check for any physical damage sustained during shipment. Notify In-Situ and file a claim with the carriers involved if there is any shipping damage. Accessories may be shipped separately and should also be inspected for physical damage and the fulfillment of your order.



Please save packing materials for future storage and shipping. The shipping boxes have been performance-tested and provide protection for the instrument and its accessories.

Warranty

See the product specification tables for warranty information.

Contact Information

Mailing and Shipping Address:

In-Situ
221 East Lincoln Avenue
Fort Collins, CO 80524-2533
U.S.A.

Phone: 970-498-1500 (international & domestic)

Fax: 970-498-1598

Internet: www.in-situ.com

Support: 800-446-7488 (U.S.A. & Canada)

Product Specifications

Rugged TROLL 100 and 200 Specifications

General	Rugged TROLL 100 and 200
Temperature ranges ¹	Operational: 0 to 50° C (32-122° F) Storage: -40-80° C (-40-176° F) Calibrated: 0-50° C (32-122° F)
Diameter	2.62 cm (1.03 in.)
Length	14.43 cm (5.68 in.)
Weight	137 g (0.30 lb)
Materials	Titanium body; Delrin nose cone, hanger, backend
Output options	Rugged TROLL 100: USB or RS232 via docking station Rugged TROLL 200: USB or RS232 via docking station; Modbus/RS485 or SDI-12 via Rugged TROLL 200 Cable; Wireless TROLL Com
Battery type & life ²	3.6 V lithium; 10 years or 2M readings
External power	Rugged TROLL 100: NA Rugged TROLL 200: 8-36 VDC
Memory	2.0 MB
Data records ³	120,000
Data logs	Rugged TROLL 100: 1 log; Rugged TROLL 200: 2 logs
Fastest logging rate	1 per second
Fastest output rate	Rugged TROLL 200 only: Modbus & SDI-12: 1 per second
Log types	Linear, Fast Linear, and Event
Sensor Type/Material	Piezoresistive; Ceramic
Range	9.0 m (30 ft) (Burst: 18 m; 60 ft) 30 m (100 ft) (Burst: 40 m; 134 ft) 76 m (250 ft) (Burst: 112 m; 368 ft)
Accuracy (FS) ⁴	±0.1%
Resolution	±0.01% FS or better
Units of measure	Pressure: psi, kPa, bar, mbar, mmHg, inHg Level: in, ft, mm, cm, m
Temperature Sensor	
Accuracy	±0.3° C
Resolution	0.01° C or better
Units of measure	Celsius or Fahrenheit
Warranty	2 years
Footnotes	¹ Temperature range for non-freezing liquids ² Typical battery life when used within the factory-calibrated temperature range ³ 1 data record = date/time plus 2 parameters logged (no wrapping) from device within the factory-calibrated temperature range, 360,000 total data points ⁴ Across factory-calibrated pressure and temperature ranges. Defined as greater than 98% of all readings fall within spec across temperature and pressure range Specifications are subject to change without notice. Delrin is a registered trademark of E.I. du Pont de Nemours and Company.

Rugged BaroTROLL Specifications

General	Rugged BaroTROLL
Temperature ranges ¹	Operational: 0-50° C (32-122° F) Storage: -40-80° C (-40-176° F) Calibrated: 0-50° C (32-122° F)
Diameter	2.62 cm (1.03 in.)
Length	14.43 cm (5.68 in.)
Weight	137 g (0.30 lb)
Materials	Titanium body; Delrin nose cone, hanger, backend
Output options	USB or RS232 via docking station; Modbus/RS485 or SDI-12 via Rugged TROLL 200 Cable
Battery type & life ²	3.6 V lithium; 10 years or 2M readings
External power	8-36 VDC
Memory	1.0 MB
Data records ³	65,000
Data logs	2 logs
Fastest logging rate	1 per minute
Fastest output rate	Modbus & SDI-12: 1 per second
Log types	Linear
Sensor Type/Material	Piezoresistive; Ceramic
Range	7.0 to 30.0 psi; 0.5 to 2 bar
Accuracy (FS) ⁴	±0.1%
Resolution	±0.01% FS or better
Units of measure	Pressure: psi, kPa, bar, mbar, mmHg, inHg
Temperature Sensor	
Accuracy	±0.3° C
Resolution	0.01° C or better
Units of measure	Celsius or Fahrenheit
Warranty	2 years
Footnotes	<p>¹ Temperature range for non-freezing liquids</p> <p>² Typical battery life when used within the factory-calibrated temperature range.</p> <p>³ 1 data record = date/time plus 2 parameters logged (no wrapping) from device within the factory-calibrated temperature range</p> <p>⁴ Across factory-calibrated pressure range and temperature ranges. Defined as greater than 98% of all readings fall within spec across temperature and pressure range</p> <p>Specifications are subject to change without notice. Delrin is a registered trademark of E.I. du Pont de Nemours and Company.</p>

Overview

Rugged TROLL Overview

The Rugged TROLL 100 and 200 instruments are designed to measure pressure, level, and temperature in natural groundwater and surface water. They also can be used at industrial sites, landfills, and other installations.

Both instruments have completely sealed housings that contain an absolute (non-vented) pressure sensor, temperature sensor, real-time clock, microprocessor, lithium battery, and internal memory.

The Rugged TROLL 100 is designed to hang by a backshell hanger from a suspension wire. The Rugged TROLL 200 can utilize the backshell hanger or can connect to a cable for easy top-of-well RS485 communications via laptop computer or mobile device. Additionally, Rugged TROLL 200 cables with stripped-and-tinned cable ends can communicate with data loggers, TROLL Link Telemetry Systems, or PLC devices via RS485 or SDI-12.

Rugged BaroTROLL Overview

The Rugged BaroTROLL measures and logs barometric pressure and temperature in air. This data is used to correct the Rugged TROLL 100 and 200 data by compensating for barometric pressure effects during the course of a log.

Communication Accessories

- Rugged TROLL 100:
 - USB or RS232 docking station
 - Wireless Rugged TROLL COM
- Rugged TROLL 100,200 and Rugged BaroTROLL Instruments:
 - USB or RS232 docking station
 - USB or RS232 Rugged TROLL Com
 - Wireless RuggedTROLL Com
- Win-Situ 5 Software or VuSitu mobile app for programming and downloading
- Optional software: Win-Situ Baro Merge for barometric compensation; Software Manager to check for updates

Other Accessories

Rugged TROLL 100

- Suspension cable
- Rugged BaroTROLL for logging barometric pressure data

Rugged TROLL 200

- Suspension cable
- Rugged BaroTROLL for logging barometric pressure data
- SDI-12 compatible cable with stripped-and-tinned uphole termination
- RS485 compatible cable with stripped-and-tinned uphole termination
- RS485 top-of-well cable
- Rugged TROLL 200 cable suspension kit (Use this kit to create a weight-bearing loop capable of suspending up to 45.5 kg (100 lbs.) of cable and instrument.)

Equipment Configuration Table

Data Logger	Deployment Options	Communication Device
Rugged TROLL 100	<u>Suspension Wire</u> –one per Rugged TROLL & <u>Rugged Baro TROLL</u> –one per network of Rugged TROLLs –requires an additional suspension wire	Wireless Rugged TROLL Com Rugged TROLL Docking Station*
Rugged TROLL 200	OPTION (A) <u>Suspension Wire</u> –one per Rugged TROLL & <u>Rugged Baro TROLL</u> –one per network of Rugged TROLLs –requires an additional suspension wire	Wireless Rugged TROLL Com Rugged TROLL Docking Station*
	OPTION (B) <u>RS485 Direct-Read Cable</u> –one per Rugged TROLL & <u>Rugged BaroTROLL</u> –one per network of Rugged TROLLs –requires additional RS485 cable for real-time data	Wireless Rugged TROLL Com Rugged TROLL Com** –one per cable for top-of-well data –one per network—download only
	OPTION (C) <u>SDI-12 Direct-Read Cable</u> & <u>Rugged BaroTROLL</u> –one per network of Rugged TROLLs –requires additional SDI-12 cable for real-time data	Wireless Rugged TROLL Com PLC/SCADA & Rugged TROLL Docking Station***

* A Rugged TROLL Docking station can connect to one data logger at a time.

** In this deployment option, make sure to include an additional Rugged TROLL Com for real-time data from the Rugged BaroTROLL.

*** In this deployment option, a Rugged TROLL Docking Station is required for communication with the data loggers when not connected to the SDI-12 Direct-Read Cable.

Getting Started

You will need the following items.

- Rugged TROLL 100 or 200 instrument
- Rugged BaroTROLL (optional)
- One of the communication devices below
 - USB or RS232 docking station and Rugged TROLL Com (for Rugged TROLL 200 and Rugged BaroTROLL).
 - Wireless Rugged TROLL Com (if using the VuSitu mobile app)

Install Software

You can configure and deploy your In-Situ instrument with the VuSitu mobile app or Win-Situ 5 software for PC. To use Win-Situ, install it from the software CD or download from www.in-situ.com. Download VuSitu on your mobile device from the Google Play Store at play.google.com.

Win-Situ 5 Software

1. Click the Win-Situ 5 link and follow the installation instructions.
2. Make sure that you select the option to "Install USB Drivers."

Win-Situ Baro Merge Software

Install Baro Merge Software if you plan to post-correct level data to compensate for barometric pressure.

About VuSitu

VuSitu is the mobile user interface and control application for In-Situ water quality instruments. You can use VuSitu on mobile devices with Android operating system 4.4, *Bluetooth* 2.0 and newer. Download the latest version of the app from the Google Play Store at play.google.com.

VuSitu allows you to accomplish the following tasks.

- View live readings that update every 10 seconds
- Change parameters and units
- Set up a data log
- Record data
- Email data in spreadsheet format
- Download data to mobile device
- Transfer data from mobile device to a computer
- Organize data by Location
- Calibrate Sensors and View Reports

Verify the VuSitu Mobile App Version

To avoid potential compatibility issues, it is important to use the most recent version of the VuSitu Mobile App. Find version information and app updates from the Google Play Store.

Connecting Your Instrument to VuSitu

To use VuSitu, you will need a Bluetooth-enabled mobile device, a Wireless TROLL Com and a deployment cable.

Attach one end of the cable to the Wireless TROLL Com and secure the other end to the instrument. Press the power button on the Wireless TROLL Com and open the VuSitu mobile app on your phone or tablet.

VuSitu will automatically search for Bluetooth devices nearby, but you will need to select the correct instrument when connecting for the first time. Select **Choose or Add a Device**. You should see the serial number of the instrument you wish to pair. Tap the serial number to connect. Tap the **Back** button on your device to view the Connected Instrument screen.

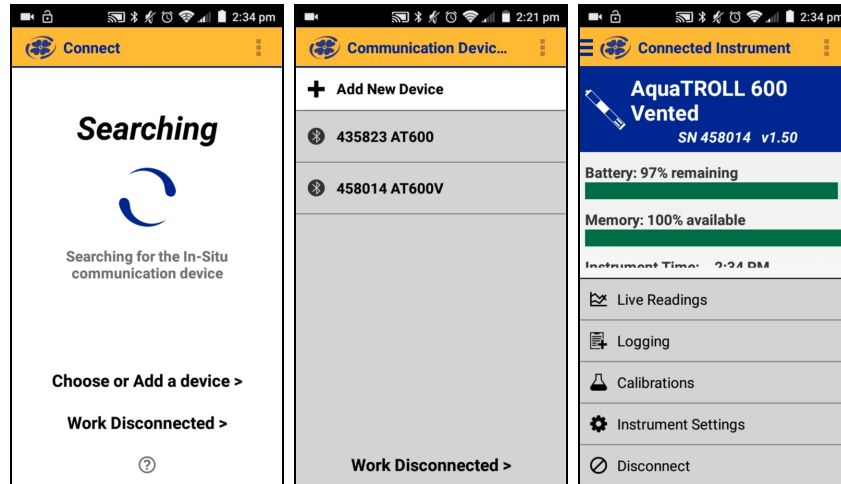

VuSitu Menu Options

The features available in the VuSitu mobile app vary slightly depending on the instrument to which it is connected. Tap the menu icon in the upper left portion of the screen to view the features included in VuSitu. Tap the menu icon again to close the menu.

Menu Options when Connected to Instrument

Some features, such as sensor calibration, are not available when you are not connected to an instrument.

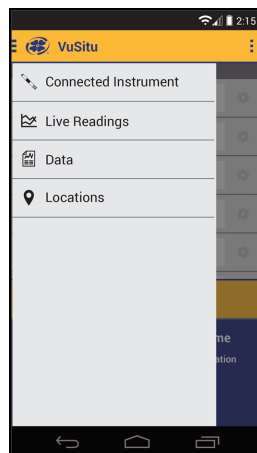

Taking live readings in VuSitu

Snapshot Mode

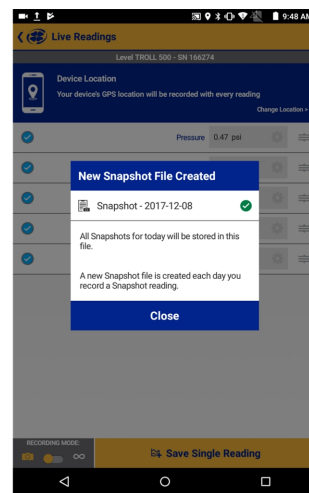

Take a single reading and save to Snapshot file.

View Snapshot file from Menu > Data Files.

Check Snapshot option.

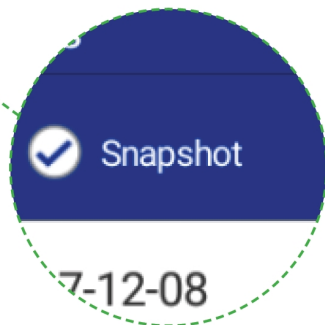
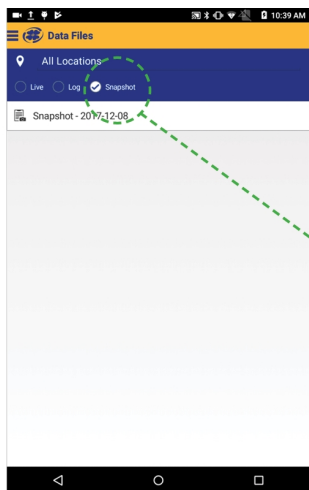

Live Readings Mode

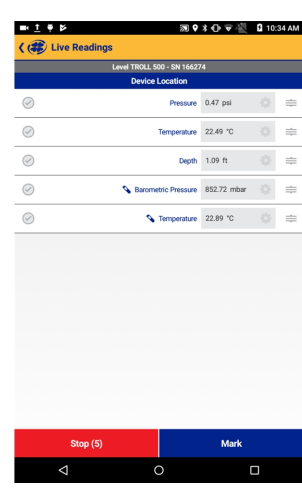

Take readings at two-second intervals.

View readings from Menu > Data Files.

Check Live option.

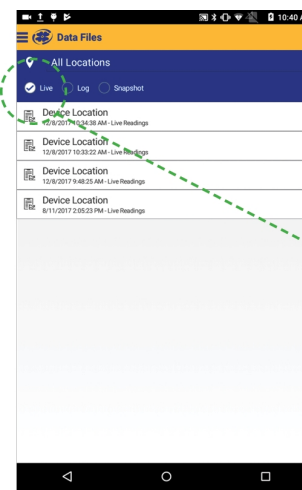

Downloading and sharing your data.

You can download VuSitu data as an HTML file and share it via email, SMS or a cloud storage service such as Google Drive. To download a log, select it from the Downloaded Data screen and tap **Save to**.

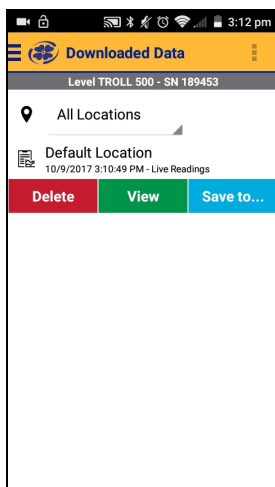

Choose one of the download options from the menu. You can transfer a data file from your mobile device to a PC via Bluetooth, email it to yourself or any valid email address, save the file to the VuSitu folder on your device or upload it to Google Drive.

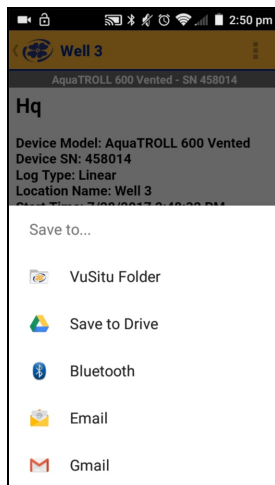

View your data in any web browser by double-clicking the file. You can then export a CSV file by clicking the **Export a CSV** link at the top of the page.

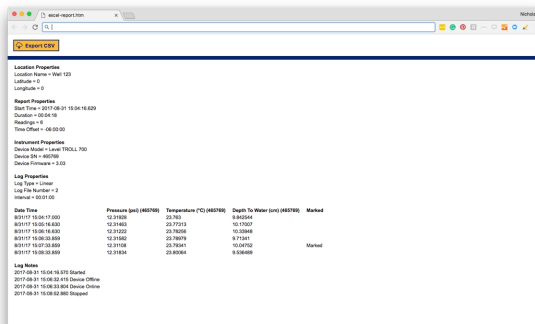

Connect to the Rugged TROLL Docking Station

The docking station is intended for use with the Rugged TROLL 100, 200 and Rugged BaroTROLL Instruments that are not deployed with a communication cable. Once connected, you can program the instrument, view readings, and download the data.

1. Unscrew and remove the hanger from the instrument.



The hanger is the only removable part of the instrument. Do not attempt to take the instrument apart. There are no user-serviceable parts in the instrument.

2. Invert the instrument. Align the notch on the instrument with the tab on the rim of the docking station. This will ensure that the pins are aligned to enable communication.
3. Place the instrument into the docking station.

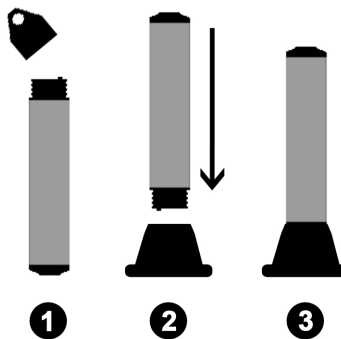

4. Connect the docking station to a computer.



Connect to the Rugged TROLL Com

The Rugged TROLL Com is used as a communication interface between a Rugged TROLL 200 or a Rugged BaroTROLL instrument, the Rugged TROLL 200 cable and a computer.

An internal 9 volt battery powers the Rugged TROLL Com, but it does not provide power to the instrument. The Rugged TROLL Com connects to the uphole end of the Rugged TROLL 200 cable. Once connected, you can program the instrument, view real-time readings, and download the data.



Do not submerge the Rugged TROLL Com Device.

Rugged TROLL Com Battery Installation

1. Open the battery compartment door.
2. Attach the battery leads to the battery terminals.
3. Push the battery into the compartment.



4. Close the battery compartment door.

Connections

1. Attach the Rugged TROLL Com to the Rugged TROLL 200 cable via snap-on connection to the uphole end of the cable.



2. Connect the communication cable to the PC.



3. The Rugged TROLL Com requires a minimum of 8 VDC. If you lose connection to the instrument, particularly when using a long cable, replace the 9 V battery on the TROLL Com.
4. Release the connection to the uphole cable end by pushing in the white tab on the TROLL Com.

Deploying the Instruments

You can deploy a Rugged TROLL Instrument with or without a Rugged BaroTROLL Instrument. Use the Rugged BaroTROLL Instrument when you want to compensate water level measurements for atmospheric pressure.

Use the following steps for each instrument.

1. Connect the instrument to a computer with Win-Situ 5 or a mobile device with VuSitu.
2. Make sure that you sync the clock .
3. Program a log. See the Win-Situ 5 or VuSitu section of this document for more details.

✓ The BaroTROLL measurements can be taken far apart as long as they cover the general time period as the Rugged TROLL log.

✓ If the Rugged TROLL log uses the reference "Set first logged reading to," the Rugged BaroTROLL log should start before the Rugged TROLL log to ensure that barometric pressure is measured when the first level reading is captured.

4. Disconnect the BaroTROLL, attach the hanger, and deploy it suspended or lying in a protected location above water level near the submerged Rugged TROLL 100 or 200. One possibility is shown in Figure 11.1 .

 Do not submerge the Rugged BaroTROLL Instrument.

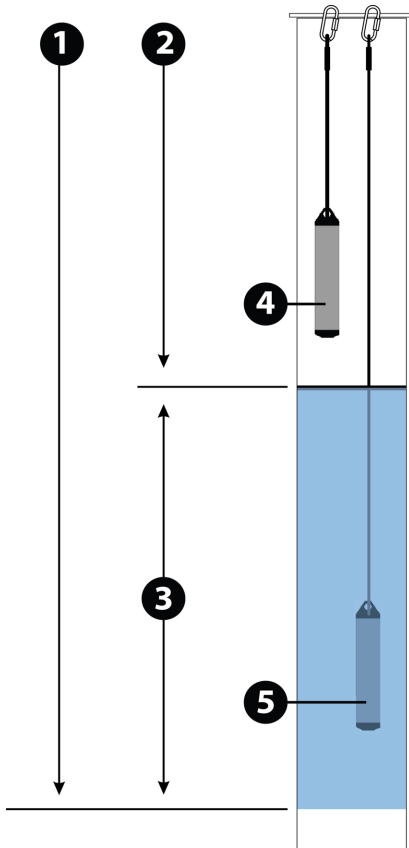

Figure 11.1 Rugged BaroTROLL and Rugged TROLL deployment

1	Pressure due to atmosphere + water column (measured by Rugged TROLL)
2	Pressure due to atmosphere (measured by Rugged BaroTROLL)

3	Pressure due to water column (calculated by subtracting Rugged BaroTROLL data from Rugged TROLL data)
4	Rugged BaroTROLL Instrument
5	Rugged TROLL Instrument

Rugged TROLL 200 Cable Suspension

When a Rugged TROLL 200 Instrument or a Rugged BaroTROLL Instrument needs to be installed with a secure fastener, such as a carabiner, In-Situ Inc. recommends using the Rugged TROLL 200 Cable Suspension Kit (Part Number 0080880).

When installed correctly the connector can support a combined cable and instrument weight of up to 45.4 kg (100 lbs).

1. Create a loop on the uphole end of the cable and loosely bind it with one zip tie.



2. Place the metal loop inside the cable loop. Push the zip tie up to form a tight band around the metal loop. Tighten the zip tie.



3. Place the second zip tie directly below the first and tighten.



4. Place the third zip tie about 2.5 cm (1 in.) below the first two ties. Place the fourth zip tie snugly against the third.



5. Hand tighten the zip ties. Do not over tighten.
6. Clip the excess tie material from the unit.



7. Deploy from a well dock or other secure location.



Wiring Connections for Stripped-and-Tinned Cable

The Rugged TROLL 200 Cable can be ordered with stripped-and-tinned wires that can be connected to an SDI-12 or RS485 data recorder or controller.

SDI-12 Connections

- Blue = serial data
- Red = 12 V power supply
- Black = ground

Terminate remaining wires at the data recorder.

SDI-12

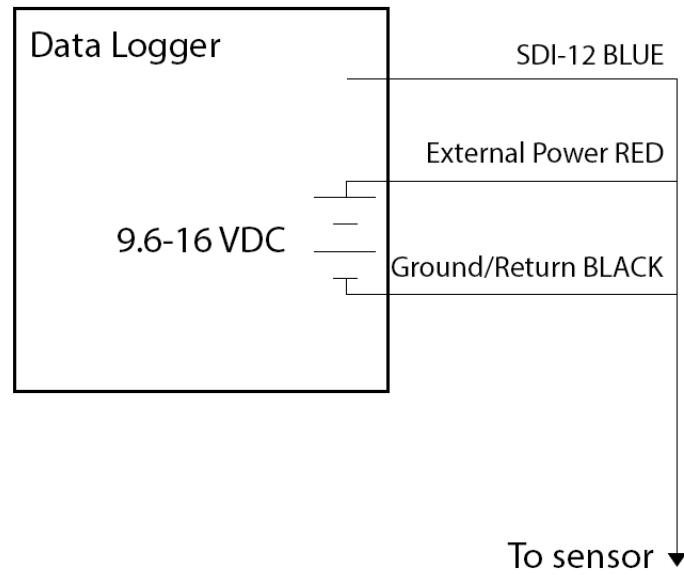

RS485 Connections

- Red = 12 V power supply
- Black = ground
- Green = RS485 (-)
- Blue = RS485 (+)

Terminate remaining wires at the data recorder.

Modbus Master

(RS485 built in)

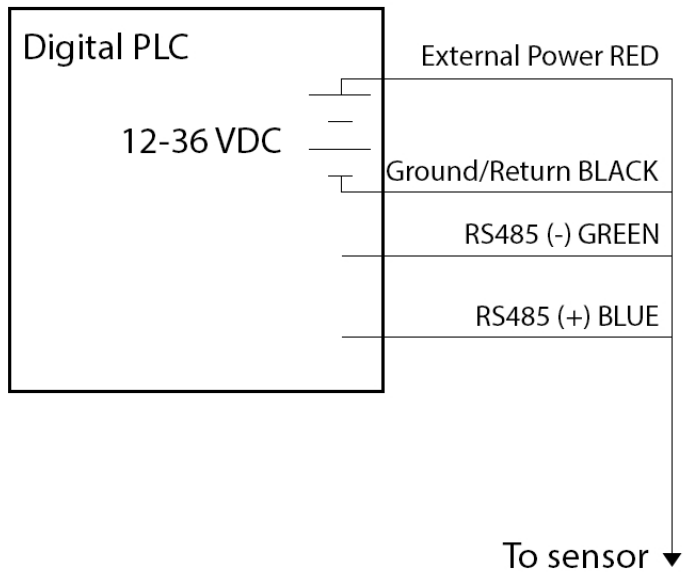





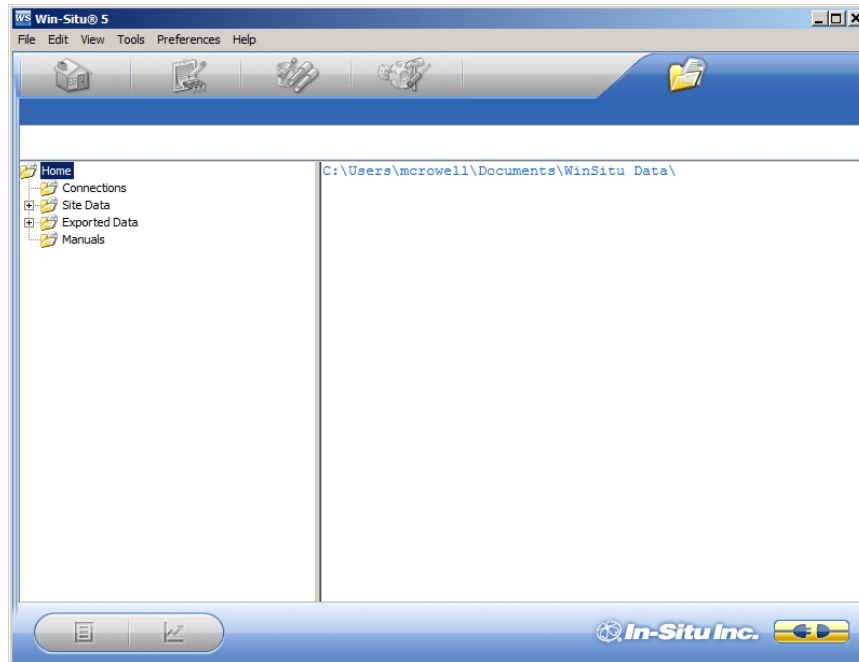

Win-Situ Overview

Data Tab

When you open Win-Situ 5 Software, the **Data** tab appears. The left side of the screen contains a file tree where you can view previously downloaded site data as well as data you have exported to Microsoft Office Excel. The links on the right side of the screen show where downloaded data are stored on your computer. The disconnected plug icon in the lower-right corner of the screen indicates that the software is not yet communicating with an instrument.







Screen Element	Definition
	The disconnected plug indicates the instrument is not communicating with the software. Click to establish communication with a connected instrument.
	The connected plug indicates the instrument is communicating with the software. Click to disconnect the software from the instrument.
	The Home tab displays real-time readings from the instrument. When connection to the instrument is first established, the software displays one reading of all available parameters in light gray. You must click the Play button  at the bottom of the screen to view real-time readings.
	The Logging tab displays a list of logs stored in the connected instrument. When you click the Logging tab, it can take a moment for the software to retrieve information from the instrument. (Not applicable for the RDO PRO-X and the Aqua TROLL 400.)



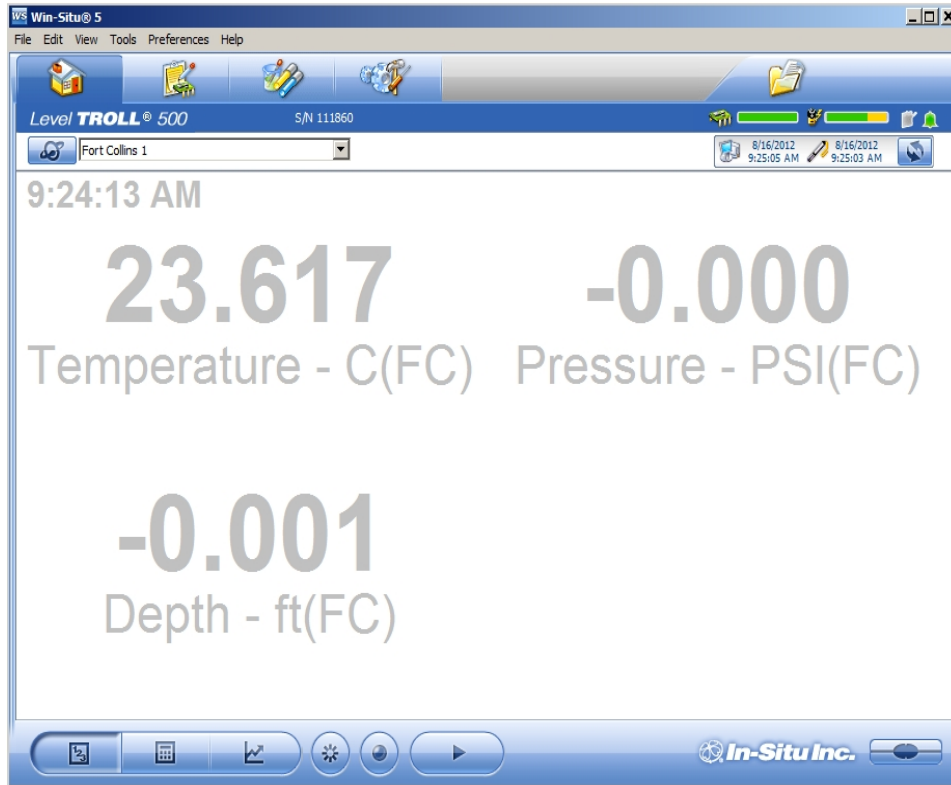



Screen Element	Definition
	The Sensors tab lists the sensors in the connected instrument, along with their serial numbers and the dates of factory calibration and user calibration. Use the buttons in this tab to calibrate sensors that support user calibration and configure sensors that are supported by the instrument.
	The Device Setup tab allows access to instrument information and settings such as instrument name, serial number, firmware version, communication settings, diagnostics, and factory reset options.



Home Tab

The **Home** tab displays real-time readings from a connected instrument. When you first establish communication, the software displays one reading of all available parameters in light gray.



Screen Element	Definition
	The Sites button allows you to add, edit, or delete a site. Click the drop-down arrow next to the button to view the list of sites.
	The Device Memory gauge turns yellow when the internal memory is used. Note: Non-logging instruments do not have internal memory, however, the gauge shows 100 percent green when power is applied.
	The Device Battery gauge turns yellow as the battery is depleted. This example shows 80 percent of the battery remaining (green) and 20 percent used (yellow). Note: Non-logging instruments do not have internal batteries, however, the gauge shows 100 percent green when power is applied.

Screen Element	Definition
	<p>The Logging Status icon:</p> <p>Green—The instrument is actively logging data.</p> <p>Gray—The instrument has no logs pending or running. Non-logging instruments always show a gray status icon.</p> <p>Yellow—The instrument has log data that was collected according to specific instructions in the "Pending" or "Suspended" state.</p>
	<p>The Alarm icon provides additional instrument status information.</p> <p>Green—No alarms or warnings</p> <p>Yellow—One or more warnings</p> <p>Red—One or more alarms</p> <p>Move the cursor over the alarm icon to view a description. Click the Device Setup tab for detailed information on the alarm or warning.</p> <p>Note: Disregard the Device Reset alarm for non-logging instruments such as the RDO PRO Probe or the Aqua TROLL 400.</p>
	<p>System Time is displayed on the left. Device Time is displayed on the right. Clocks are updated once every two seconds. When the Device Time is displayed in red, it differs from the current System Time, and should be synchronized.</p>
	<p>The Time Sync button is used to write the current PC time to the instrument. If you need to set the instrument clock to a time other than the system (PC) time, use the Set Clock button on the Device Setup tab.</p>
	<p>Meter View shows the last known parameter values, displayed with current units and time stamp. Readings are sized to occupy the entire screen. This is the default display in the Home tab. If the type is black, the readings are updating in real time.</p>
	<p>List View is a running list of the most recent records. New readings are continuously added to the top of the list and old readings scroll off the bottom.</p>
	<p>Graph View shows a real-time trend graph of the selected parameters.</p>

Screen Element	Definition
	The Snapshot button records one set of readings.
	The Record button logs data to a CSV file that can be opened in a spreadsheet program. This is not the same as recording data in a log on the instrument.

Logging Tab

The **Logging** tab displays a list of logs in the instrument. When you click the **Logging** tab, it may take a moment for the software to retrieve information from the instrument.

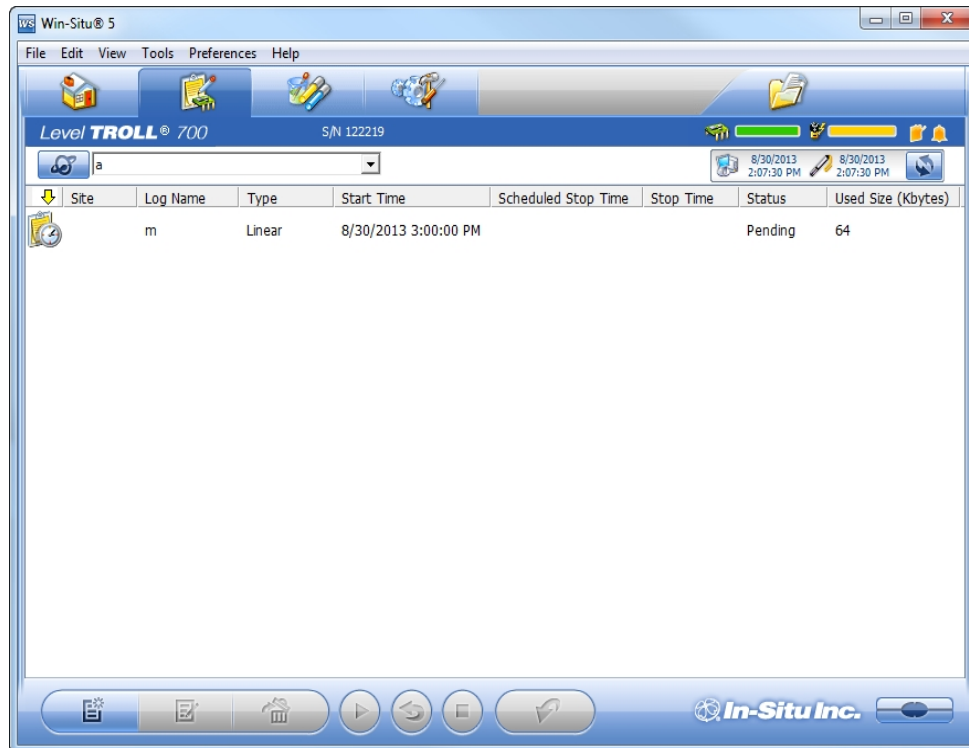

Log Information

Columns across the **Logging** screen show information about the logs in the instrument.







- **Symbol**—This is a graphic representation of the information in the **Status** column.
- **Site**—The site that was specified when the log was configured.
- **Log Name**—The name that was entered when the log was configured.
- **Type**—The logging method that was selected when the log was configured.
- **Start Time**—For a Pending log, the scheduled start time is shown. For a Ready log that has not yet started, this column displays “Manual.” For a Running or Stopped log, the actual start time is shown.
- **Scheduled Stop Time**—For a log with a scheduled stop, the scheduled stop time is shown. For a log without a scheduled stop time, this column is blank.
- **Stop Time**—For a Pending or Ready log, this column is blank. For a Running log, the time of the last data point is shown. For a Stopped log, the actual stop time is shown.
- **Status**—Each log has a specific status. See **Log Status** for details.
- **Used Size**—Kilobytes of instrument memory allocated for this log. For a Pending or Ready log, the current size of the log configuration is shown. For a Completed log, the size of the entire log file is shown. For a Running log, the current size of the log up to the last data point is shown.

Log Status

The status of each log in the instrument is displayed in the Logging tab by a symbol beside the log name, and in the Status column.



Ready—Manual Start log is ready to start.





-
-  **Pending**—Scheduled start log is ready to start at its programmed time, or when you click the **Start** button.
 -  **Running**—The log is actively logging data.
 -  **Suspended**—The log has been paused (stopped temporarily).
 -  **Stopped**—The log has been stopped, either manually or on a schedule.
 -  **Deleted**—The log has been marked for deletion and will be deleted from the instrument when memory is needed. The software manages this automatically.
 -  **Invalid**—The log as programmed cannot be run.



Ready, Pending, Running, and Suspended logs are considered active. Only one log can be active in the instrument.



Log Control Buttons

You can control the status of a log by selecting the log and clicking the appropriate button in the **Logging** tab control panel:

-  The **Start** button starts a **Ready** or **Pending** log, or resumes a **Suspended** log.
-  The **Pause** button pauses a **Running** log allowing you the option to resume it.
-  The **Restart** button restarts the selected **Running** log from the beginning. This can be useful during aquifer testing using a logarithmic data collection schedule.
-  The **Stop** button permanently stops the selected **Running** log.

Log Operations

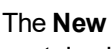
Use the buttons in the control panel to perform the following actions:

-  Create a new log.
The **New** button is disabled if a Ready, Pending, Running, or Suspended log is on the instrument. When the instrument contains its maximum number of logs, the New button is unavailable.
-  **Edit** (or review) the log configuration for a Ready, Pending, or Invalid log.
-  **Delete** the log. (Note that you must delete a log twice before it is permanently removed.)
-  **Download** the log to a PC.

Sensors Tab

The **Sensors** tab lists the sensors in the instrument, along with their serial numbers and calibration dates. Use the buttons in this tab to calibrate and configure sensors.

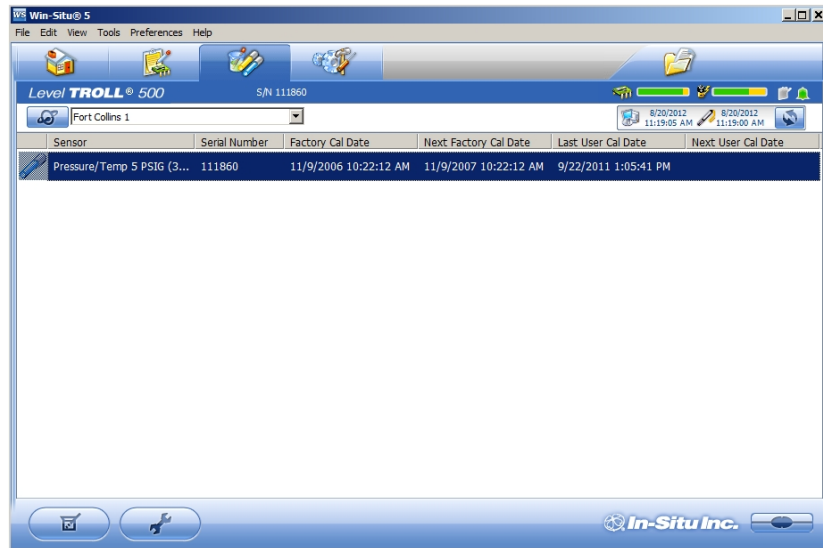

Calibrate

Use the **Calibration** button to calibrate sensors or to adjust a level reference that is currently stored on the instrument. The **Calibrate** button is not available when the instrument does not support calibration (e.g. BaroTROLL Instrument).

1. With the instrument connected to the software, select the **Sensors** tab.
2. Select the parameter you intend to calibrate.
3. Click the **Calibrate** button .

Configure

Use the **Configure** button to select parameter units and to configure parameters that support configuration. Examples include Level/Depth, Specific Conductivity, and Total Dissolved Solids. Parameters cannot be configured while the instrument is showing live data on the **Home** screen or while the instrument contains an active log.

1. With the instrument connected to the software, select the **Sensors** tab.
2. Select the parameter you intend to configure.
3. Click the **Configure** button .



When you configure the Level parameter using the **Sensors** tab, the settings are stored in the instrument and are available for use in Modbus, SDI-12, or analog communication (if available). If desired, a different configuration can be selected when setting up a log.

Device Setup Tab

In general, you should not use the **Device Setup** tab unless you are corresponding with the In-Situ technical support team. However, you can use this screen to set up communication protocols if you are connecting the instrument to a PLC or data logger.

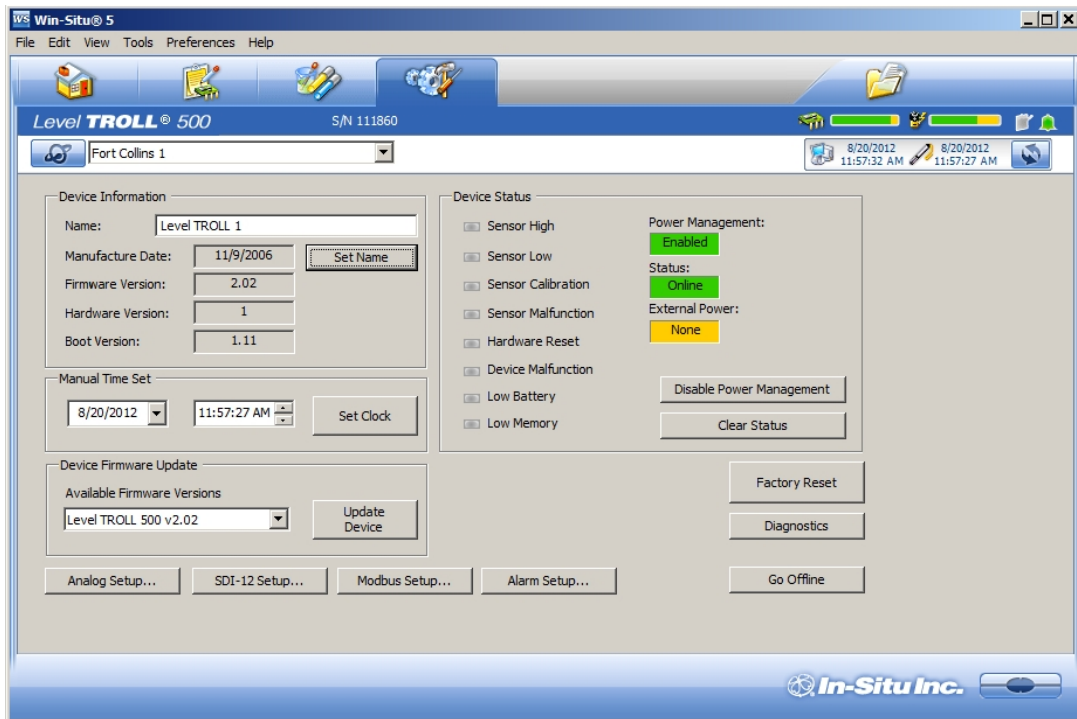

See the online Help for more details.

Using Win-Situ 5 Software

Connecting an Instrument to the Software

When you open Win-Situ 5 Software, you are asked if you want to connect to your device. Click **Yes**. Synchronize the instrument clock to the PC clock. 

The software displays an error message if a connection cannot be established.

Selecting the Correct COM Port

If you are using a USB TROLL Com, select the correct COM port by following the steps below. If you are using a serial TROLL Com, the Win-Situ Software should default to the correct COM port, which is usually COM 1.

Steps for Windows 8.1 and Windows 10 systems.

1. Right-click the **Start** button.
2. Click **Device Manager**.
3. Click the arrow next to **Ports (COM and LPT)**, and locate the USB Serial Port listing. The number listed next to this entry is your COM port address.

Steps for Windows 8 systems.

1. Right-click the **Start** screen.
2. Select **All Apps**.
3. Click **Control Panel**.
4. Open the **Device Manager**.
5. Click the arrow next to **Ports (Com and LPT)**, and locate the USB Serial Port listing. The number listed next to this entry is your COM port address.

Steps for Windows 7 systems.

1. Click the **Start** button, and open the **Control Panel**.
2. Click **Hardware and Sound**, and open the **Device Manager**.
3. Click the arrow next to **Ports (COM and LPT)**, and locate the USB Serial Port listing. The number listed next to this entry is your COM port address.

Steps for Windows XP systems.

1. Click the **Start** button, and open the **Control Panel**.
2. Double-click the **System** icon. Click the **Hardware** tab, and open the **Device Manager**.
3. Click the plus sign next to **Ports (COM and LPT)**, and locate the USB Serial Port listing. The number listed next to this entry is your COM port address.



The following steps apply for all Windows operating systems.

1. Once you have determined the correct COM port address in your operating system, reopen Win-Situ 5 Software.
2. Close any open windows in Win-Situ Software.
3. Click **Preferences**.
4. Click **Comm Settings**, and then click the **Port Number** menu.

5. Scroll down to find the correct COM port address. Click the **check mark** to accept the changes.
6. Click the yellow **Connect** button in the lower right corner to establish a connection to the instrument.

Bluetooth & Wireless TROLL Com

Alternatively, your instrument can communicate with Win-Situ software via a Wireless Rugged TROLL Com and Bluetooth. Connect the cable to the Wireless TROLL Com and the Rugged TROLL instrument. Turn on the Wireless TROLL Com and open Win-Situ 5. Choose **File > Connect** to access the Default Communication Settings window.

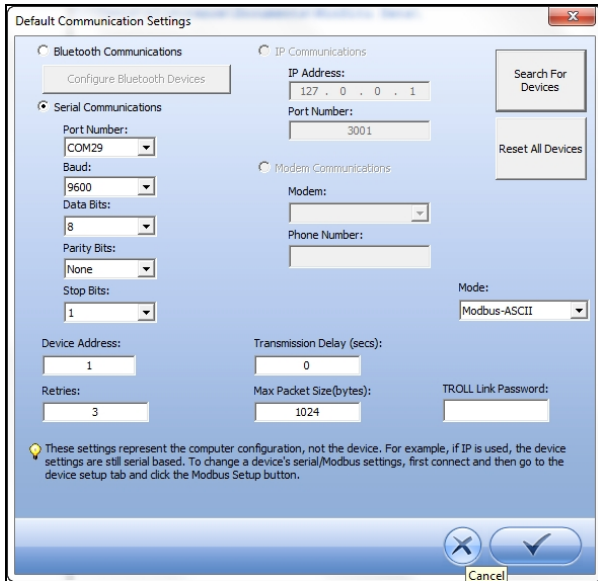

Select the radio button labeled **Bluetooth Communications** and click **Configure Bluetooth Devices**. You will see a list of nearby Bluetooth devices. Click the Wireless TROLL Com you are using and click the check mark.

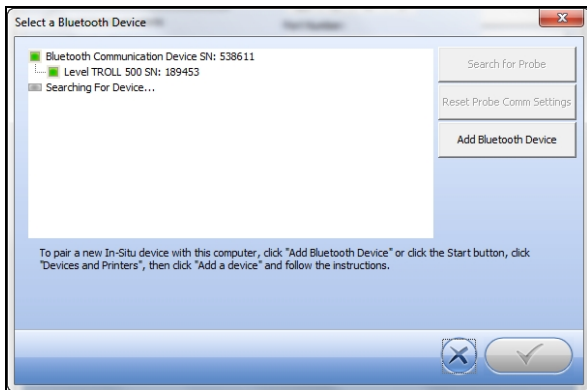

Finally, click the yellow **Connect** button  at the bottom right of the screen to complete the connection.

Setting the Instrument Time

The instrument time and the current PC time are shown at the top of the screen when an instrument is connected to the software.

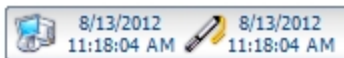

The PC time appears on the left, the instrument time on the right. Both clocks are updated at 0.5 Hz (once every two seconds). The device time is displayed in red if it differs by more than a few seconds from the current PC time. Data logging schedules depend on a correct instrument time.

To synchronize the instrument time to the current PC time, click the **Clock Sync** button . Win-Situ writes the current PC time to the instrument.

Adding a New Site

To add a new site to the site database in your working directory do one of the following:

On the **Data** tab, click the **Site Data** folder, select **File> New > Site**.

or



On the **Home** tab, click the **Site** button to display the site list, then click **New**. Enter a name for the site. This is the only required field.

Click **Save** to save the new site. The new site will appear in the **Site Data** folder, and Win-Situ will add it to the site database in the working directory on your computer. It is now available to select for any instrument log.

Log Setup

The Log Setup Wizard presents sequential screens to help you supply all the information necessary to set up a data log in the instrument.

To access the Log Setup Wizard the instrument must be connected to the software.

1. Click the **Logging** tab .
2. Click the **New** button .



The **New** button may be disabled or may show a warning if an active log already exists on the instrument, or if the instrument is polling live data (see the **Home** screen), or if the device already contains its maximum number of logs.

3. Select the **Site** where the set of data will be logged and supply a name for the log.
4. Click the **right arrow** to continue after each step.
5. Select the parameters you intend to measure, choose the measurement units, and specify the order in which the selected parameters will be logged.
6. Select the logging method you intend to use. See page 33.
7. Select the log interval. A log interval is how often a measurement will be taken and stored.
8. Select the start condition, stop condition, and specify how to handle full device memory.
9. If you selected **Level** or **Depth** as a parameter to measure, specify how you intend to log this parameter. See page 34.
10. The final screen summarizes the log setup. Click the **check mark** to write this information to the instrument.

Logging Method Descriptions

The following is a list of log types and their descriptions. The log types that are available on an instrument vary depending upon the capabilities of the instrument.

Logging Methods for Long-Term Monitoring

Linear

Linear log type measures and records at a user-defined fixed interval of one minute or more. This method is used for long-term studies, landfill monitoring, stream gauging, tidal studies, and background monitoring prior to aquifer testing. Intervals are measured in days, hours, or minutes.

Linear Average

Linear Average log type can smooth out anomalous highs and lows that may occur in a data set, for example, when a water wave passes over the instrument. Each stored measurement is the average of several rapid measurements. This method is used for long-term studies, stream gauging, tidal and open-water studies where trends are more important than accuracy. Intervals are measured in days, hours, minutes, or seconds.

Event

Linear Event log type combines basic fixed-interval logging of specified parameters with the ability to log data at a faster interval when a single-parameter event condition is present.

About the Level Reference

A Level Reference, also called an offset, is a user-specified starting point for logged Level readings. It is entered in the Logging Setup Wizard when a log is configured, or it can be stored in the device without configuring a log using the **Configure** button in the **Sensors** tab.

Depth mode does not require that you enter a Level Reference.

The Level Reference can be any value you choose. Here are some examples:

- **Elevation**—If you calculate the water level above mean sea level (MSL) and enter this as the Level Reference, then elevations above MSL will be logged.
- **Depth to Water**—If you measure the depth to the water surface (DTW) from the top of the well casing and enter this as the Level Reference, then DTW (also called drawdown) values will be logged.
- **Gauge Height or Stage**—Logged readings track water level as related to markings on a nearby staff gauge.
- **Zero**—A Level Reference of 0 effectively sets the probe to zero at the start of the log. Changes, both positive and negative, from the starting water level, will be logged.

Once you have determined the value of your Level Reference, the software gives you three options for entering it. These control when the level reference is applied.

- **New Reference**—This option is designed to be used with an active software connection when the device is installed in the water.



A new level reference must be entered while the device's pressure sensor is submerged in its final position in the water. This is because the current probe reading is set equal to the Level Reference to create the offset that takes effect at the start of the data log. The log header will show the probe reading at the time you entered the Level Reference.

During log setup, the software presents two additional options for entering the Level Reference:

- **Set first logged reading**—Use this option when the instrument will be deployed on wire rather than cable because you will not be able to communicate with the instrument when it is submerged.
- **Remind me to set reference later**—Use this option to defer the entry of the Level Reference during log setup and set a reminder to enter it when the device is submerged in its final position.

Starting a Log

Every log is programmed for either a manual or a scheduled start. A log with a manual start time is displayed in the Logging screen with **Ready** in the **Status** column. A log with a scheduled start time is displayed with **Pending** in the **Status** column.

Starting a Pending Log

A **Pending** log automatically starts at the scheduled time without any user intervention.



A scheduled log with **Pending** status can be manually started at any time before its scheduled start.

Starting a Manual Log



With the instrument connected to the software, select the **Logging** tab.

Select the Ready log you want to start.

Click the **Start Log** button . The log starts and the symbol changes. The **Status** column displays **Running**.

Suspending (Pausing) a Log

A running log may be temporarily paused. For example, you might want to reposition an instrument, calibrate a sensor, or clean a sensor and later resume the log. A log can be suspended and resumed three times.

1. With the instrument connected to the software, select the **Logging** tab .
2. Select the log you intend to suspend.
3. Click the **Suspend** button . **Suspended** appears in the **Status** column.

Resuming a Suspended Log



1. To resume logging after a log has been suspended, select the **Logging** tab.
2. Select the **Suspended** log.
3. Click the **Start Log** button . Logging resumes. **Running** appears in the **Status** column. The data file will show the time when the log was suspended and the time when it restarted.

Stopping a Log

A log can be manually stopped at any time, even if a stop time has been previously scheduled. If you did not specify a stop condition when you defined the log, the log will run until the instrument is out of memory or battery power, or until you manually stop it.





A log that has been stopped cannot be resumed. If you intend to resume a log later, you should suspend a log rather than stop it.

1. To manually stop a log, the instrument must be connected to the software.
2. Select the **Logging** tab .
3. Select the running log you intend to stop.
4. Click the **Stop Log** button .

Downloading Data to a PC

This procedure copies the data log from the instrument to a PC. It does not remove the data log from the instrument. After a log is downloaded, it can be exported to a CSV file format that can be used by spreadsheet programs. The time shown in the log name is the time the log was downloaded.

1. With an instrument connected, select the **Logging** tab .
2. Select the log you intend to download.
3. Choose a Running, Suspended, Stopped, or Deleted log.
4. Click the **Download**  button.
5. In the next screen, select one of the three download options.
 - All data
 - New data (data logged since the last download)
 - Time interval to download



New data is downloaded by default to a new log file. To append new data to the last download of this log, be sure the option "Append logs on download" is selected in the **General Settings** dialog (**Preferences > General Settings**).

2. The log is copied to the connected PC into your Win-Situ working directory folder. View or change the working directory using **File > Settings**.
3. At the end of the download, Win-Situ gives you the option of viewing the data.
 - Select **Yes** and the log is displayed in the **Data** screen.
 - Select **No** and the **Logging** screen appears. You can view the data at any time by selecting it in the **Data** tab.

Viewing Logged Data

1. To view the data stored in the instrument, you must first download the data. A connection to an instrument is not needed after the data log has been downloaded.
2. Select the **Data** tab .
3. On the left side of the screen, select the log you want to view. To expand a folder shown in the navigation tree, double-click the folder. The content of the data log is displayed on the right side of the screen in text or graph format.



To switch between view formats, click the **Text** or the **Graph** button in the control panel. To customize the text or graph view, select **Preferences > Graph Settings** or **Preferences > Data View Settings**. These options apply to all downloaded data until you change the options.

Importing VuSitu Data to Win-Situ

You can import data files from VuSitu into Win-Situ 5 from the File menu.

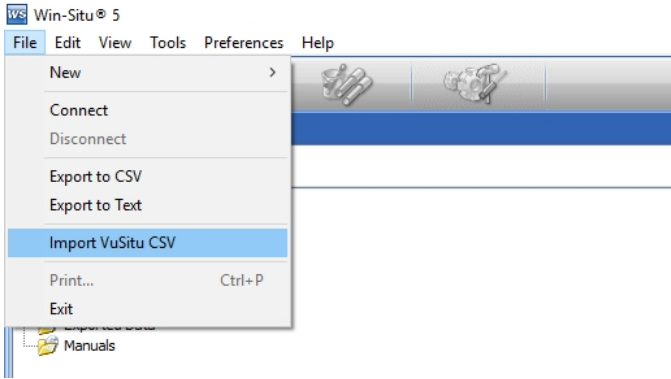

A. Click **File > Import VuSitu CSV** in the menu bar at the top of the screen.

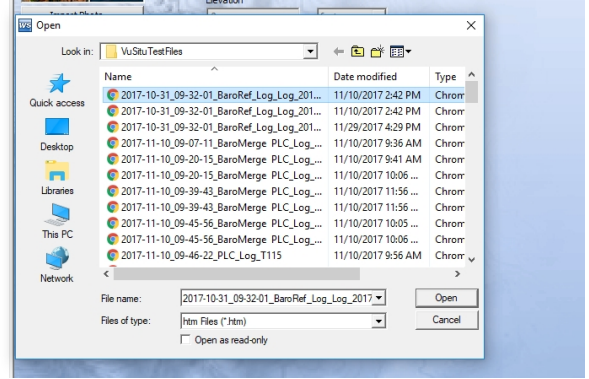

B. Select the file you wish to import and click **Open**.

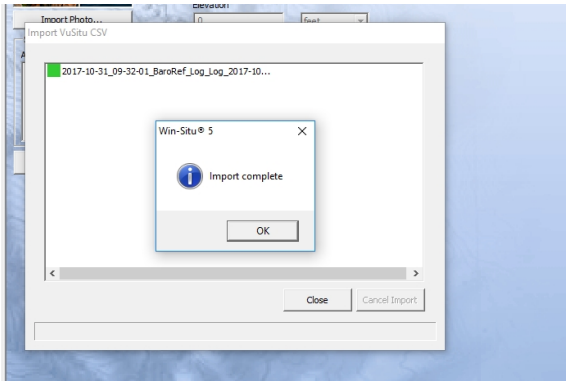

C. Select **OK** at the prompt.

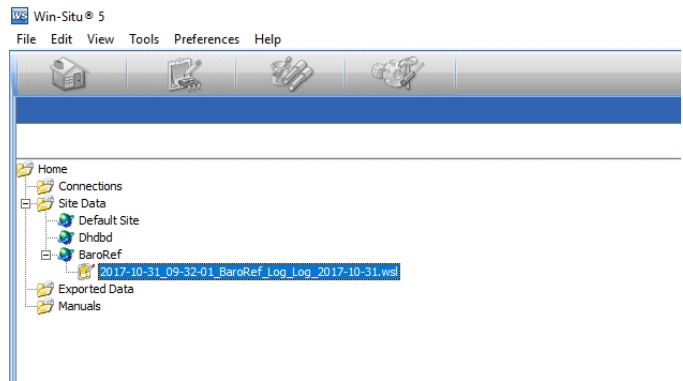

D. Click on the file name to view it.

Using BaroMerge Software

BaroMerge Software is used to post-correct absolute (non-vented) level sensor data to eliminate barometric pressure effects from the measurements. BaroMerge Software can be accessed through the Win-Situ 5 Software **Tools** menu. BaroMerge provides three options to correct data.

- **Fixed Correction**—A single offset value is applied to all selected log data. Use this option if you know the barometric pressure of the site during the log, and know that it did not change.
- **Manual Entry**—Specify two or more correction values to apply to the log data. Use this option if you wish to manually enter a data set of barometric pressure values.
- **BaroTROLL log file**—Absolute level sensor data points are individually corrected to reflect barometric pressure changes that were logged by a BaroTROLL instrument during the approximate time period.



Baro Merge Input—Fixed Correction

If you select the **Apply a fixed correction** option, a single correction is applied to all values in the log.

To use this correction method you need barometric pressure values from a reliable source. Choose a single value that represents the actual ambient barometric pressure during the time period the log was recorded. You also need to know the file names of the logs you want to correct.

1. From the **Tools** menu, select **Win-Situ Baro Merge**.



2. Select the **Apply a fixed correction** option.
3. Enter the barometric correction value and select units from the drop-down menu.
4. Click the **right arrow** button.
5. Select the log files to which the correction will be applied and click the **check mark** button.
6. Compensated data files can be viewed or exported from the **Data** tab.

Baro Merge Input—Manual Entry

When you select the **Fixed Correction** and **Manual Entry** options, it is important to know the barometric pressure for the general time period covered by the log or logs you want to correct.

1. From the **Tools** menu, select **Win-Situ BaroMerge**.



2. Select the **Enter one or more values manually** option.
3. The compensation table appears that allows you to build a table of barometric data that corresponds to the time the log was recorded. The compensation table has three preference options:

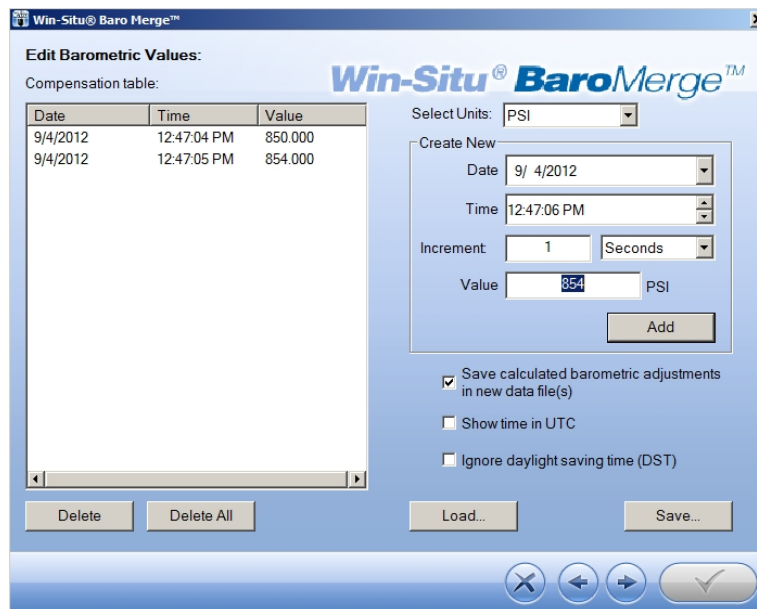

- The first option, **Save calculated barometric adjustments in the new data file(s)** is the default option. It adds additional columns depending on which parameters were selected for the absolute/non-vented log in the corrected BaroMerge file that uses the compensation table values. This is intended to show how the adjustments were done in the BaroMerge file. If you do not want to show these adjustments, clear this option.

-
- When the second option, **Show time in UTC** is selected, the compensation table time stamp displays in Coordinated Universal Time (UTC) time, formally known as Greenwich Mean Time (GMT).
 - If the third option, **Ignore daylight saving time (DST)** is selected, the compensation table time stamp format without the daylight savings time adjustment will be shown.
3. Build a table that contains at least two barometric pressure values.
 4. Click the right arrow and select the absolute (non-vented) log file or files you intend to correct.
 5. Click the check mark and the barometric compensation is applied.
 6. Compensated data files can be viewed or exported from the **Data** tab.

BaroMerge Output

Your original log file is not changed. A new, corrected log file with the same name and path is created. The original “.wsl” extension is replaced by “-Baro Merge.wsl”.

Disconnecting an Instrument from the Software

Click the plug icon  in the lower-right corner of the screen to disconnect the instrument from the software.

Disconnect the instrument from the communication device. Attach a desiccant pack if you are using a vented cable.

Maintenance, Cleaning, and Storage

O-ring Inspection and Replacement

Examine O-rings for wear, dryness, discoloration, stretching, cracks, nicks, and brittleness. Replace O-rings when any of these conditions are present. Replacing O-rings on an annual basis, regardless of their condition, is the best way to protect against moisture damage.

Perform the following steps to replace an O-ring.

1. Remove and discard the damaged O-ring.
2. Use a clean, dry, soft cloth to clean the O-ring groove to remove dirt or residue.
3. Lubricate the new O-ring using high-vacuum grease.
 - a. Wash your hands thoroughly.
 - b. Apply a small amount of grease to the pad of your index finger, and rub your index finger and thumb together to spread the grease evenly.
 - c. Inspect the new O-ring and remove any debris stuck to it.
 - d. Rub your fingers around the O-ring until there is a thin layer of grease on the entire O-ring.
4. Install the O-ring in the groove and remove any excess lubricant with a clean cloth.

Do not allow water or lubricant to enter the connector.

Cleaning the Instrument

Clean the instrument body with water and a soft brush or plastic scouring pad, or soak overnight in a mild acidic solution, such as household vinegar. **NEVER** submerge the connector portion of the instrument when it is not connected to a cable.

If the ports near the pressure sensor are clogged with silt or mud, try the following procedures.

- Agitate the instrument vigorously in a bucket of clean water.
- Apply a gentle rinse of water from a wash bottle.

Do not attempt to remove material from the instrument by tapping the instrument against a surface. **You void the instrument's warranty by inserting anything into the sensor opening.** If contamination cannot be removed using the recommendations above, please contact In-Situ for cleaning.

Storage

Store the instrument in a clean, dry place. Store the instrument where it will not roll off a bench onto a hard surface or sustain other mechanical shock. Protect the instrument from temperature extremes.

Store the Rugged TROLL within the temperature range -40°C to $+80^{\circ}\text{C}$ (-40°F to $+176^{\circ}\text{F}$).

Service

Return Materials Authorization (RMA) Form

To obtain a factory calibration, fill out and return the online Return Materials Authorization (RMA) form located at www.in-situ.com/.

Obtaining Repair Service

If you suspect your system is malfunctioning and repair is needed, you can help assure efficient servicing by following these guidelines:

1. Call or email In-Situ Technical Support. Have the product model and serial number available.
2. Be prepared to describe the problem, including how the product was used and the conditions noted at the time of the malfunction.
3. If Technical Support determines that service is needed, they will ask your company to fill out the RMA form and pre-approve a specified monetary amount for repair charges. When the form and pre-approval is received, Technical Support will assign an RMA (Return Material Authorization) number.
4. Clean the product as described in the manual.
5. If the product contains a removable battery, remove and retain it unless you are returning the system for a refund or Technical Support states otherwise.
6. Carefully pack your product in its original shipping box, if possible.
7. Mark the RMA number clearly on the outside of the box.
8. Send the package, shipping prepaid, to:

In-Situ
ATTN: Repairs
221 East Lincoln Avenue
Fort Collins, CO 80524-2533

The warranty does not cover damage during transit. In-Situ recommends insurance for all shipments. Warranty repairs will be shipped back prepaid.

Outside the U.S.

Contact your international In-Situ distributor for repair and service information.

Guidelines for Cleaning Returned Equipment

Please help us protect the health and safety of our employees by cleaning and decontaminating equipment that has been subjected to any potential biological or health hazards, and labeling such equipment. Unfortunately, we cannot service your equipment without such notification. Please complete and sign the form in your Operator's Manual (or a similar statement certifying that the equipment has been cleaned and decontaminated) and send it with each returned instrument.

- We recommend a cleaning solution, such as Alconox[®], which is a glassware cleaning product available from In-Situ (part number 0029810) or laboratory supply houses.
- Clean all cabling. Remove all foreign matter.
- Clean cable connector(s) with a clean, dry cloth. Do not submerge cable connectors.
- Clean the probe body—including the nose cone, cable head, and protective caps. Remove all foreign matter.

If an instrument is returned to our Service Center for calibration or repair without a statement that it has been cleaned and decontaminated, or in the opinion of our Service Representatives presents a potential health or biological hazard, we reserve the right to withhold service until proper certification has been obtained.

Decontamination and Cleaning Form

Decontamination & Cleaning Statement

Company Name _____ Phone _____

Address _____

City _____ State _____ Zip _____

Instrument Type _____ Serial Number _____

Contaminant(s) (if known) _____

Decontamination procedure(s) used _____

Cleaning verified by _____ Title _____

Date _____



Declarations of Conformity and Similarity

Rugged TROLL 100

Manufacturer: In-Situ, Inc.
221 East Lincoln Avenue
Fort Collins, CO 80524
USA

Declares that the following product:

Product name: Rugged TROLL
Model: Rugged TROLL 100
Product Description: The Rugged TROLL measures and logs level and temperature in natural groundwater and surface water.

is in compliance with the following Directives:

89/336/EEC for Electromagnetic Compatibility (EMC) Directive
73/23/EEC for Safety Directive

and meets or exceeds the following international requirements and compliance standards:

- **Immunity**
EN 61326:1997, Including Amendments A1:1998, A2:2001, A3:2003,
Electric Equipment for Measurement, Control and Laboratory Use
- **Emissions**
Class A requirements of EN 61326:1997, Electric Equipment for Measurement, Control
and Laboratory Use

Supplementary Information:

The device complies with the requirements of the EU Directives 89/336/EEC and 73/23/EEC, and the CE mark is affixed accordingly.

Date of Issue: April 26, 2010

Signature: 
Name: Bruce Barker
Title: Director of New Product Development



Rugged TROLL 200

Manufacturer: In-Situ, Inc.
221 East Lincoln Avenue
Fort Collins, CO 80524
USA

Declares that the following product:

Product name: Rugged TROLL
Model: Rugged TROLL 200
Product Description: The Rugged TROLL measures and logs level and temperature in natural groundwater and surface water.

is in compliance with the following Directives:

89/336/EEC for Electromagnetic Compatibility (EMC) Directive
73/23/EEC for Safety Directive

and meets or exceeds the following international requirements and compliance standards:

- **Immunity**
EN 61326:1997, Including Amendments A1:1998, A2:2001, A3:2003,
Electric Equipment for Measurement, Control and Laboratory Use
- **Emissions**
Class A requirements of EN 61326:1997, Electric Equipment for Measurement, Control
and Laboratory Use

Supplementary Information:

The device complies with the requirements of the EU Directives 89/336/EEC and 73/23/EEC, and the CE mark is affixed accordingly.

Date of Issue: April 26, 2010

Signature: 
Name: Bruce Barker
Title: Director of New Product Development



**EMC Verification
Declaration of Similarity**

Equipment

Type of equipment: Measurement instrumentation
Product name: Rugged BaroTROLL®
Model: Rugged BaroTROLL

Manufacturer: In-Situ, Inc.
221 East Lincoln Avenue
Fort Collins, CO 80524
USA

Category

Standards

Emission: EN 61326 & FCC Part 15, Subpart B
Immunity: EN61326

Summary

We confirm that the equipment referenced above, without reasonable doubt, will fulfill the requirements concerning electromagnetic compatibility according to the above mentioned standards harmonized with the EMC Directive 89/336/EEC. The Rugged TROLL 200 was tested and found to be in compliance in the month of April 2010.

Date of Issue: July 3, 2013

Signature:



Name: Jon Firooz
Title: Vice President, Research and Development