

Operator's Manual

Level TROLL[®] 400, 500, 700, 700H Instruments



Copyright © 2013 by In-Situ All rights reserved.

This document contains proprietary information which is protected by copyright. No part of this document may be photocopied, reproduced, or translated to another language without the prior written consent of In-Situ

**Mailing and Shipping
Address:**

In-Situ
221 East Lincoln Avenue
Fort Collins, CO 80524
U.S.A.

Phone: 970-498-1500 (international & domestic)

Fax: 970-498-1598

Internet: www.in-situ.com

Support: 800-446-7488 (U.S.A. & Canada)

In-Situ makes no warranty of any kind with regard to this material, including, but not limited to, its fitness for a particular application. In-Situ will not be liable for errors contained herein or for incidental or consequential damages in connection with the furnishing, performance, or use of this material.

In no event shall In-Situ Inc. be liable for any claim for direct, incidental, or consequential damages arising out of, or in connection with, the sale, manufacture, delivery, or use of any product.

In-Situ and the In-Situ logo, Win-Situ, TROLL, Baro Merge, BaroTROLL, HERMIT, HydroVu™, iSitu, Pocket-Situ, RDO, RuggedCable, RuggedReader, SmarTROLL™, TROLL, VuSitu™, and Win-Situ are trademarks or registered trademarks of In-Situ Inc. Microsoft and Windows are registered trademarks of Microsoft Corporation. Pentium is a registered trademark of Intel. Tefzel and Delrin are registered trademarks of E. I. DuPont de Nemours and Company. Viton is a registered trademark of DuPont Dow Elastomers. Kellems is a registered trademark of Hubbell Inc. Alconox is a registered trademark of Alconox Company. Lime-A-Way is a registered trademark of Reckitt Benckiser. Android is a trademark of Google Inc. iPod and iPhone are trademarks of Apple Inc., registered in the U.S. and other countries. The Bluetooth word mark and logos are registered trademarks owned by the Bluetooth SIG, Inc. and any use of such marks by In-Situ Inc. is under license. NIST is a registered trademark of the National Institute of Standards and Technology, U.S.A. Other brand names and trademarks are property of their respective owners.



The presence of the Waste Electrical and Electronic Equipment (WEEE) marking on the product indicates that the device is not to be disposed via the municipal waste collection system of any member state of the European Union.

For products under the requirement of WEEE directive, please contact your distributor or local In-Situ office for the proper decontamination information and take back program, which will facilitate the proper collection, treatment, recovery, recycling, and safe disposal of the device.

0052210 | Rev. 009

Table of Contents

1 Introduction	7
Scope	7
Serial Number Location	7
Certification	7
Unpacking and Inspection	7
Warranty	7
Contact Information	7
2 Product Specifications	8
Level TROLL 400 Instrument	8
Level TROLL 500 Instrument	9
Level TROLL 700 Instrument	11
Level TROLL 700H Instrument	12
BaroTROLL Instrument	13
RuggedCable System	14
Suspension Wire	14
3 About the Pressure/Level Sensor	15
Absolute Pressure Sensor	15
Gauged Pressure Sensor	15
BaroTROLL Atmospheric Pressure Sensor	16
Configuring Depth and Level for PLC or Data Logger	16
4 System Components	18
Instrument	18
RuggedCable System	18
Vented or Non-Vented Cable	18
Jacket Options	18
Customizable Cable Lengths	18
Cable Termination	18
Suspension Wire	20
Communication Cables	21
Description	21
Contents	22
Charging the Communication Device	22
Battery Tips	22
Connecting to a Wireless TROLL Com	22
Power Options	24
Internal Power—Batteries	24
AC Adapter	24
External Power—External Battery Packs	24
TROLL Battery Pack	24
TROLL Replaceable Battery Pack	25
Estimated Battery Lifetime	25

Installation Accessories	26
NPT Adapter	26
Cable Extender	26
Twist-Lock Hanger	26
Bulkhead Connector	27
Locking Well Cap	27
Well Dock Installation Ring	28
5 Software	28
About VuSitu	28
Connecting Your Instrument to VuSitu	29
VuSitu Menu Options	29
Menu Options when Connected to Instrument	29
Live Readings Screen	30
Record Data	30
Changing Parameters and Units	32
6 Getting Started	33
Select a TROLL Com Communication Device	33
Connecting RuggedCable	35
Connect the Instrument to the RuggedCable	35
Connect TROLL Com Communication Device to the RuggedCable System	35
Install the Software	36
Win-Situ 5 Software	36
7 Field Deployment	37
Program the Instrument	37
Position the Instrument	37
Verify Instrument Depth	38
Secure the Cable	38
Install the Desiccant	39
Desiccant	39
Installation Guidelines	39
Stabilization Time	40
BaroTROLL Instrument Installation	41
Programming the Baro TROLL Instrument	41
Installation	41
8 Win-Situ Overview	43
Data Tab	43
Home Tab	45
Logging Tab	48
Sensors Tab	50
Device Setup Tab	50
9 Using Win-Situ 5 Software	52
Connecting an Instrument to the Software	52

Selecting the Correct COM Port	52
Bluetooth & Wireless TROLL Com	53
Setting the Instrument Time	53
Adding a New Site	54
Log Setup	54
Logging Method Descriptions	54
Logging Methods for Long-Term Monitoring	54
Linear	54
Linear Average	55
Event	55
Logging Methods for Aquifer Testing	55
True Logarithmic	55
Fast Linear	55
Step Linear	55
About the Level Reference	55
Starting a Log	56
Starting a Pending Log	56
Starting a Manual Log	56
Suspending (Pausing) a Log	56
Resuming a Suspended Log	56
Stopping a Log	56
Downloading Data to a PC	57
Viewing Logged Data	57
Using BaroMerge Software	59
BaroMerge Input—BaroTROLL File	59
BaroMerge Output	60
Disconnecting an Instrument from the Software	61
10 Connect to a Data Logger or PLC Controller	61
Wiring	63
Analog (4-20 mA) 2 Wire	64
SDI-12 3 Wire	65
Modbus Master	66
Modbus Master with RS232 (Converter Required)	67
Power Connections	68
Communication Protocols	68
Redundant Logging	68
11 Cleaning and Maintenance	70
Overview	70
Operating Considerations	70
Temperature	70
Pressure Range	70
Batteries	70
Desiccant Pack Options	71

Small Desiccant	71
Large and Extra Large Desiccant	71
Outboard Desiccant	71
Desiccant Refill Kit	72
Installing Desiccant with Twist-Lock Connectors	72
Installing Outboard Desiccant	72
Using the Desiccant Refill Kit	73
Antifouling	73
TROLL Shield Nose Cone	73
O-ring Inspection and Replacement	74
Cleaning and Storage	75
Cleaning the Instrument	75
Twist-Lock Connectors	75
Storage	75
Factory Calibration and Service	76
In-House Factory Calibration	76
Return Materials Authorization (RMA) Form	76
Obtaining Repair Service	76
Guidelines for Cleaning Returned Equipment	77
12 Decontamination and Cleaning Form	78
13 Troubleshooting	79
14 Declarations of Conformity and Similarity	81

Introduction

The Level TROLL Instrument is a compact, modular system for measuring level and temperature in natural groundwater, surface water, industrial waters, and other installations.

Scope

This document is intended to describe the characteristics, operation, calibration, and maintenance of the instrument. Communication registers and SDI-12 programming information can be found in the Modbus and SDI-12 Reference Guides on the In-Situ website.

Serial Number Location

The serial number is engraved on the instrument housing. It is also programmed into the instrument and is displayed when the instrument is connected to a computer running Win-Situ Software.

Certification

See the Declarations of conformity at end of this manual.

Unpacking and Inspection

Your instrument was carefully inspected before shipping. Check for any physical damage sustained during shipment. Notify In-Situ and file a claim with the carriers involved if there is any shipping damage. Accessories may be shipped separately and should also be inspected for physical damage and the fulfillment of your order.



Please save packing materials for future storage and shipping. The shipping boxes have been performance-tested and provide protection for the instrument and its accessories.

Warranty

See the product specification tables for warranty information.

Contact Information

Mailing and Shipping Address:

In-Situ
221 East Lincoln Avenue
Fort Collins, CO 80524
U.S.A.

Phone: 970-498-1500 (international & domestic)

Fax: 970-498-1598

Internet: www.in-situ.com

Support: 800-446-7488 (U.S.A. & Canada)

Product Specifications

Level TROLL 400 Instrument

General	Level TROLL 400
Temperature ranges ¹	Operational: -20-80° C (-4-176° F) Storage: -40-80° C (-40-176° F) Calibrated: -5-50° C (23-122° F)
Diameter	1.83 cm (0.72 in.)
Length	21.6 cm (8.5 in.)
Weight	124 g (0.27 lb)
Materials	Titanium body; Delrin nose cone
Output options	Modbus/RS485, SDI-12, 4-20 mA
Battery type & life ²	3.6 V lithium; 10 years or 2M readings
External power	8-36 VDC
Memory	2.0 MB
Data records ³	130,000
Data logs	50
Log types	Linear, Fast Linear, and Event
Fastest logging rate & Modbus rate	2 per second
Fastest SDI-12 & 4-20 mA output rate	1 per second
Real-time clock	Accurate to 1 second/24-hr period
Sensor Type/Material	Piezoresistive; titanium
Calibrated Range (Usable Depth)	<i>Absolute (non-vented)</i> 30 psia (11 m, 35 ft) 100 psia (60 m, 197 ft) 300 psia (200 m, 658 ft) 500 psia (341 m, 1120 ft)
Burst pressure	Max. 2x range; burst > 3x range
Accuracy @ 15° C ⁴	±0.05% full scale (FS)
Accuracy (FS) ⁵	±0.1% (FS)
Long-term stability ⁶	< 0.1% FS
Resolution	±0.005% FS or better
Units of measure	Pressure: psi, kPa, bar, mbar, mmHg, inHg, cmH ₂ O, inH ₂ O Level: in, ft, mm, cm, m
Temperature Sensor	
Accuracy & resolution	±0.1° C; 0.01° C or better
Units of measure	Celsius or Fahrenheit
Warranty	3 years Extended warranties are available for all instruments—call for details

Footnotes

- ¹ Temperature range for non-freezing liquids
² Typical battery life when used within the factory-calibrated temperature range
³ 1 data record = date/time plus 2 parameters logged (no wrapping) from device within the factory-calibrated temperature range
⁴ Across factory-calibrated pressure range
⁵ Across factory-calibrated pressure and temperature ranges
⁶ Includes linearity and hysteresis over one year
Specifications are subject to change without notice.
Delrin is a registered trademark of E.I. du Pont de Nemours and Company.

Level TROLL 500 Instrument

General	Level TROLL 500
Temperature ranges ¹	Operational: -20-80° C (-4-176° F) Storage: -40-80° C (-40-176° F) Calibrated: -5-50° C (23-122° F)
Diameter	1.83 cm (0.72 in.)
Length	21.6 cm (8.5 in.)
Weight	124 g (0.27 lb)
Materials	Titanium body; Delrin nose cone
Output options	Modbus/RS485, SDI-12, 4-20 mA
Battery type & life ²	3.6 V lithium; 10 years or 2M readings
External power	8-36 VDC
Memory	2.0 MB
Data records ³	130,000
Data logs	50
Log types	Linear, Fast Linear, and Event
Fastest logging rate & Modbus rate	2 per second
Fastest SDI-12 & 4-20 mA output rate	1 per second
Real-time clock	Accurate to 1 second/24-hr period
Sensor Type/Material	Piezoresistive; titanium
Calibrated Range (Usable Depth)	<i>Gauged (vented)</i> 5 psig (3.5 m, 11.5 ft) 15 psig (11 m, 35 ft) 30 psig (21 m, 69 ft) 100 psig (70 m, 231 ft) 300 psig (210 m, 692 ft) 500 psig (351 m, 1153 ft)
Burst pressure	Max. 2x range; burst > 3x range
Accuracy @ 15° C ⁴	±0.05% full scale (FS)
Accuracy (FS) ⁵	±0.1% FS
Resolution	±0.005% FS or better
Units of measure	Pressure: psi, kPa, bar, mbar, mmHg, inHg, cmH ₂ O, inH ₂ O Level: in, ft, mm, cm, m
Temperature Sensor	
Accuracy & resolution	±0.1° C; 0.01° C or better
Units of measure	Celsius or Fahrenheit

Warranty	3 years Extended warranties are available for all instruments—call for details
Footnotes	See See page 8.

Level TROLL 700 Instrument

General	Level TROLL 700
Temperature ranges ¹	Operational: -20-80° C (-4-176° F) Storage: -40-80° C (-40-176° F) Calibrated: -5-50° C (23-122° F)
Diameter	1.83 cm (0.72 in.)
Length	21.6 cm (8.5 in.)
Weight	124 g (0.27 lb)
Materials	Titanium body; Delrin nose cone
Output options	Modbus/RS485, SDI-12, 4-20 mA
Battery type & life ²	3.6 V lithium; 10 years or 2M readings
External power	8-36 VDC
Memory Data records ³ Data logs	4.0 MB 260,000 50
Log types	Linear, Fast Linear, Linear Average, Event, Step Linear, True Logarithmic
Fastest logging rate & Modbus rate	4 per second
Fastest SDI-12 & 4-20 mA output rate	1 per second
Real-time clock	Accurate to 1 second/24-hr period
Sensor Type/Material	Piezoresistive; titanium
Calibrated Range (Usable Depth)	<i>Absolute (non-vented)</i> 30 psia (11 m, 35 ft) 100 psia (60 m, 197 ft) 300 psia (200 m, 658 ft) 500 psia (341 m, 1120 ft) 1000 psia (693 m, 2273 ft) <i>Gauged (vented)</i> 5 psig (3.5 m, 11.5 ft) 15 psig (11 m, 35 ft) 30 psig (21 m, 69 ft) 100 psig (70 m, 231 ft) 300 psig (210 m, 692 ft) 500 psig (351 m, 1153 ft)
Burst pressure	Max. 2x range; burst > 3x range
Accuracy @ 15° C ⁴	±0.05% FS
Accuracy (FS) ⁵	±0.1% FS
Resolution	±0.005% FS or better
Units of measure	Pressure: psi, kPa, bar, mbar, mmHg, inHg, cmH ₂ O, inH ₂ O Level: in, ft, mm, cm, m
Temperature Sensor	
Accuracy & resolution	±0.1° C; 0.01° C or better
Units of measure	Celsius or Fahrenheit
Warranty	3 years Extended warranties are available for all instruments—call for details
Footnotes	See See page 8.

Level TROLL 700H Instrument

Comply with the Office of Surface Water by using the most accurate pressure transducer available. The Level TROLL 700H meets the surface-water specification of ± 0.01 foot.

For accuracy under all operating conditions, instruments are calibrated over the full pressure and temperature range. Each instrument includes a serialized, NIST-traceable calibration report.

General	Level TROLL 700H
Temperature ranges ¹	Operational: -20-80° C (-4-176° F) Storage: -40-80° C (-40-176° F) Calibrated: 0-40° C (32-104° F)
Diameter	1.83 cm (0.72 in.)
Length	21.6 cm (8.5 in.)
Weight	124 g (0.27 lb)
Materials	Titanium body; Delrin nose cone
Output options	Modbus/RS485, SDI-12, 4-20 mA
Battery type & life ²	3.6 V lithium; 10 years or 2M readings
External power	8-36 VDC
Memory Data records ³ Data logs	4.0 MB 260,000 50
Log types	Linear, Fast Linear, Linear Average, Event, Step Linear, True Logarithmic
Fastest logging rate & Modbus rate	4 per second
Fastest SDI-12 & 4-20 mA output rate	1 per second
Real-time clock	Accurate to 1 second/24-hr period
Pressure Sensor Type/Material	Piezoresistive; titanium
Calibrated Range (Usable Depth)	<i>Gauged (vented)</i> 15 psig (11 m, 35 ft)
Burst pressure	Max. 2x range; burst > 3x range
Accuracy ⁵	± 0.01 foot up to 15 ft and $\pm 0.1\%$ of reading > 15 ft
Resolution	$\pm 0.005\%$ FS or better
Units of measure	Pressure: psi, kPa, bar, mbar, mmHg, inHg, cmH ₂ O, inH ₂ O Level: mm, cm, m, in, ft,
Temperature Sensor	
Accuracy & resolution	$\pm 0.1^\circ$ C; 0.01° C or better
Units of measure	Celsius or Fahrenheit
Warranty	3 years Extended warranties are available for all instruments—call for details
Footnotes	See See page 8.

BaroTROLL Instrument

The titanium BaroTROLL measures and logs barometric pressure and temperature. Use the BaroTROLL in conjunction with non-vented In-Situ Instruments.

Win-Situ BaroMerge Software simplifies post-correction of water level data by automatically subtracting barometric readings from data collected by a non-vented instrument to compensate for changes in pressure due to barometric fluctuations.

General	BaroTROLL
Temperature ranges ¹	Operational: -20-80° C (-4-176° F) Storage: -40-80° C (-40-176° F) Calibrated: -5-50° C (23-122° F)
Diameter	1.83 cm (0.72 in.)
Length	21.6 cm (8.5 in.)
Weight	124 g (0.27 lb)
Materials	Titanium body; Delrin nose cone
Output options	Modbus/RS485, SDI-12, 4-20 mA
Battery type & life ²	3.6 V lithium; 10 years or 2M readings
External power	8-36 VDC
Memory	1.0 MB
Data records ³	65,000
Data logs	2
Log types	Linear
Fastest logging rate & Modbus rate	1 per minute
Fastest SDI-12 & 4-20 mA output rate	1 per second
Real-time clock	Accurate to 1 second/24-hr period
Sensor Type/Material	Piezoresistive; titanium
Calibrated Range (Usable Range)	30 psia (usable up to 16.5 psi, 1.14 bar)
Burst pressure	Vacuum/over-pressure above 16.5 psi damages sensor
Accuracy @ 15° C ⁴	±0.1% FS
Accuracy (FS) ⁵	±0.2% FS
Resolution	±0.005% FS or better
Units of measure	Pressure: psi, kPa, bar, mbar, mmHg, inHg, cmH ₂ O, inH ₂ O
Temperature Sensor	
Accuracy & resolution	±0.1° C; 0.01° C or better
Units of measure	Celsius or Fahrenheit
Warranty	3 years Extended warranties are available for all instruments—call for details
Footnotes	See See page 8.

RuggedCable System

General	RuggedCable System
Operating temp. range	-25° to 80° C (-13° to 176° F)
Jacket options	TPU (thermoplastic polyurethane) Tefzel (ETFE fluoropolymer; generic equivalent to Teflon)
Vent options	Non-vented (absolute) Vented (gauged) with desiccant (used to mitigate moisture/humidity)
Conductors	6 conductors, 24 AWG, polypropylene insulation
Cable diameter	TPU: 6.7 mm (0.265 in.) Tefzel: 6.35 mm (0.25 in.)
Connector diameter	18.5 mm (0.73 in.)
Weight	Non-vented, TPU: 16 kg/300 m (35.6 lbs/1,000 ft) Non-vented, Tefzel: 14 kg/300 m (32 lbs/1,000 ft) Vented, TPU: 14 kg/300 m (32 lbs/1,000 ft) Vented, Tefzel: 14 kg/300 m (32 lbs/1,000 ft)
Minimum bend radius	2X cable diameter (13.5 mm; 0.54 in.)
Break strength	127 kg (280 lbs)
Maximum cable length	1,219 m (4,000 ft) for RS485
Desiccant pack (required for vented systems)	Large and extra large desiccant packs available with titanium, ABS, or stripped-and-tinned termination.
Warranty	2 years
	Specifications are subject to change without notice.

Suspension Wire

General	Suspension Wire
Material	304 stainless steel, 7 x 7 strand
Coating	15 mil polyester elastomer insulation
Weight	0.28 kg / 30 m (0.60 lb / 100 ft)
Break strength	122 kg (270 lb) with proper clip tightening
	Specifications are subject to change without notice.

About the Pressure/Level Sensor

A pressure transducer senses changes in pressure, measured in force per square unit of surface area, exerted by water or other fluid on an internal media-isolated strain gauge. In-Situ offers instruments with either absolute (non-vented) or gauged (vented) pressure sensors.



The "Absolute vs. Gauged: Comparing Absolute and Gauged Pressure Sensors" technical note describes the difference between absolute and gauged pressure sensors and explains the proper use of each type of sensor in different applications.

Absolute Pressure Sensor

An absolute or non-vented pressure sensor measures all pressure forces detected by the strain gauge, including atmospheric pressure (P_{ATM}). The unit of measure is PSIA (pounds per square inch absolute), measured with respect to zero pressure. The back of an absolute pressure sensor is sealed from the atmosphere. Therefore, the front of the absolute pressure sensor responds to both atmospheric pressure and the pressure head of water above the sensor.

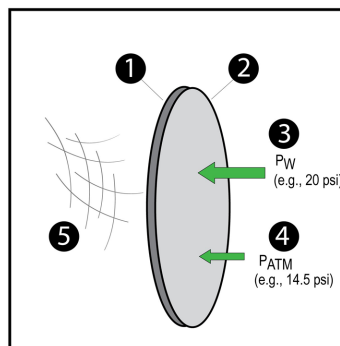

	Absolute Sensor
1	Sensor back
2	Sensor front
3	Water pressure, P_W (e.g., 20 PSI)
4	Atmospheric pressure P_{ATM} (e.g., 14.5 PSI)
5	Vacuum

Gauged Pressure Sensor

A gauged or vented pressure sensor eliminates the effects of atmospheric pressure because the vent tube in the cable allows atmospheric pressure to be applied to the back of the sensor. The unit of measure is PSIG (pounds per square inch gauge), measured with respect to atmospheric pressure.

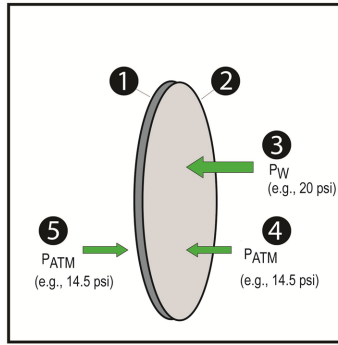

Gauged Pressure Sensor

1	Sensor back
2	Sensor front
3	Water pressure, P_W (e.g., 20 PSI)
4	Atmospheric pressure P_{ATM} (e.g., 14.5 PSI)
5	Atmospheric pressure P_{ATM} (e.g., 14.5 PSI)

BaroTROLL Atmospheric Pressure Sensor

Barometric pressure applies a direct stress upon open wells and surface water. Locally, barometric effects can change significantly from location to location as a result of topographical and micro-meteorological changes. Therefore, it is important to compensate for the barometric pressure changes when monitoring water elevation.

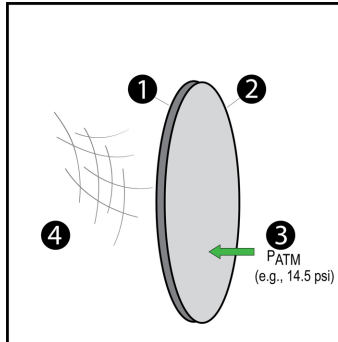

BaroTROLL Sensor

1	Sensor back
2	Sensor front
3	Atmospheric pressure P_{ATM} (e.g., 14.5 PSI)
4	Vacuum

Configuring Depth and Level for PLC or Data Logger

When you configure level using the **Sensors** tab, the settings are stored in the instrument and are available for use in Modbus, SDI-12, or 4-20 mA analog communication. A different configuration can be selected when you set up a log.

1. Connect the instrument to the software.

2. Click the **Sensors** tab .

3. Select the level/pressure sensor and click the **Configure**  button. The Sensor Setup window appears.

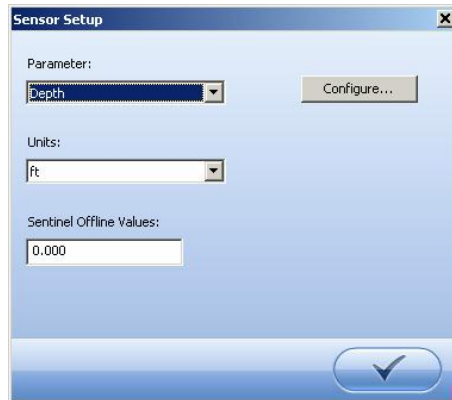

4. In the **Sensor Setup** window, select the Level parameter, then click **Configure**. The Level Setup Wizard opens.

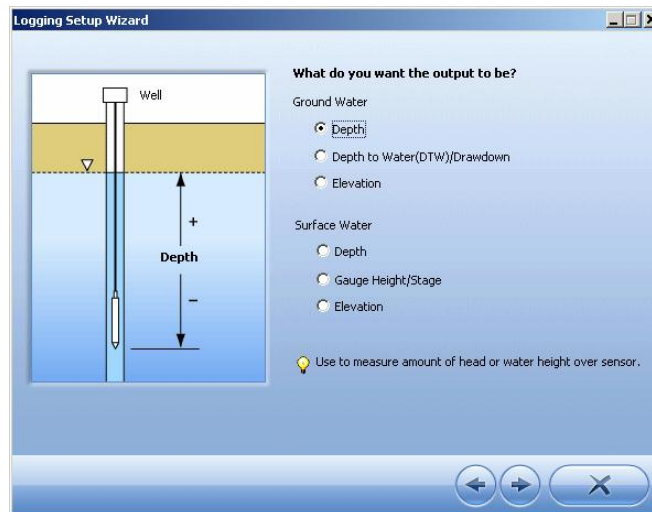

5. In the Level Setup Wizard, select the options you want. For more information, view the Help in the Win-Situ 5 Software.

System Components

Instrument

The Level TROLL Instrument is completely sealed and contains no user-serviceable parts. The instrument includes pressure and temperature sensors, a real-time clock, microprocessor, sealed lithium battery, data logger, and memory. Options include a vented or non-vented pressure sensor in a variety of ranges.

RuggedCable System

RuggedCable Systems are custom-built, durable, direct-read cables that include the following items.

- Titanium twist-lock connectors for quick, reliable connections to the instrument, desiccant, and communication cable
- Metal shield beneath the cable jacket to prevent electrical interferences
- Kellems grip for secure instrument deployment
- Small desiccant for vented systems (for storage only)



Non-vented cables are marked with VF, which means vent free.

Vented or Non-Vented Cable

Vented cable is used with vented pressure sensors to produce gauged measurements. The cable vent tube ensures that atmospheric pressure is applied to the back of the sensor diaphragm.

Non-vented cable is used with non-vented instruments for absolute measurements. Compensate absolute measurements by using a BaroTROLL Instrument and Win-Situ Baro Merge Software.



Vented cable is shipped with a small desiccant to protect against condensation. Larger desiccants are necessary for deployment.

Jacket Options

Tefzel (vented) or thermoplastic polyurethane (TPU, vented or non-vented)

Customizable Cable Lengths

Cables can be ordered up to 1,219 m (4,000 ft).

Cable Termination

Cables can be ordered with a twist-lock termination (female connector) on both ends that connect to the instrument, the TROLL Com Communication Device, desiccant, and other accessories.

Cables can also be ordered with stripped-and-tinned termination for wiring to a data logger or controller using SDI-12, analog (4-20 mA), or Modbus communication protocol.



1	RuggedCable System with female to female connectors
2	Stripped-and-tinned RuggedCable System with female connector
3	Stripped-and-tinned RuggedCable System with male connector (short length that converts a cable with a twist-lock connector to a stripped-and-tinned cable)

Suspension Wire

Polyurethane-coated stainless steel suspension cable can be used to deploy instruments with non-vented pressure sensors such as the Level TROLL 400 Instrument, the non-vented Level TROLL 700 Instrument, and the BaroTROLL Instrument. Suspension wire is appropriate to use when direct communication with the instrument is not necessary during deployment.



Description	Part Number
Suspension Wire - 300 feet	0066450
Suspension Wire - 150 feet	0066460
Suspension Wire - 50 feet	0066470

Communication Cables

The TROLL Com Communication Device provides an interface between the instrument and a desktop/laptop PC for calibrating and programming the instrument and for profiling and downloading data. The TROLL Com Communication Device is offered in either a cable-connect or direct-connect configuration including a 0.9 m (3 ft) vented polyurethane cable, external power input jack, and vent with replaceable membrane.

Description

The *Wireless TROLL Com* enables wireless communication between a Bluetooth 2.0-enabled Android or Windows device and an instrument deployed on a cable. You can also use the Wireless TROLL Com as a replacement for a standard wired TROLL Communication Device.

The *Wireless Rugged TROLL Com* permits wireless transmission between a Bluetooth 2.0-enabled device and a Rugged TROLL data logger. You must use a Direct Read Rugged TROLL cable with the Wireless Rugged TROLL Com.

Direct Read Rugged TROLL Cable

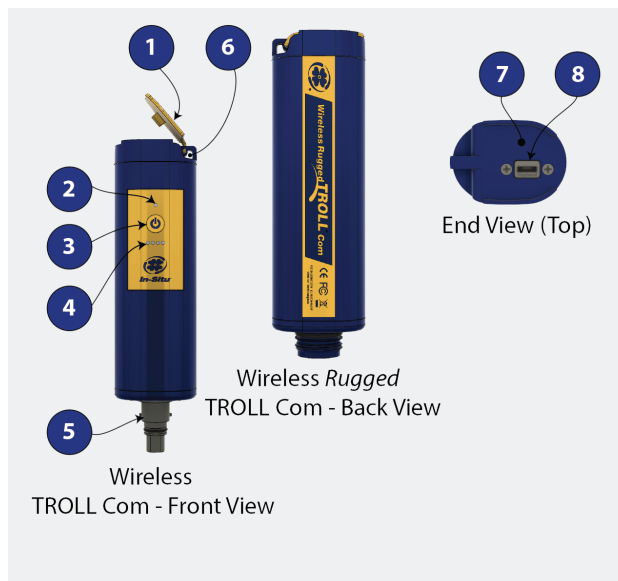

1	<p>Dust cover for the USB connection</p>
2	<p>Connection status</p> <p>Red (flashing) = The communication device, instrument, and Bluetooth-enabled device are not connected.</p> <p>Red (continuous) = The communication device and instrument are connected, but the communication device is not connected to the Bluetooth-enabled device.</p> <p>-OR-</p> <p>The communication device is connected via USB cable.</p> <p>Green (flashing) = The communication device is connected to the Bluetooth-enabled device, but is not connected to the instrument.</p> <p>Green (continuous) = The communication device, instrument, and Bluetooth-enabled device are connected.</p>

3	On/Off button
4	<p>Battery charge status:</p> <p>●●●● 100% - 90%</p> <p>●●●○ 90% - 75%</p> <p>●●○○ 75% - 50%</p> <p>●○○○ 50% - 25%</p> <p>●○○○ Less than 25%</p>
5	Cable connector to the instrument
6	Lanyard connector
7	Serial number
8	USB connection to a power source for charging the internal battery or wired connection to a computer

Contents

- Wireless TROLL Com
- USB cable
- AC wall charger (U.S.A. only, universal charger sold separately)
- Lanyard

Charging the Communication Device

1. Remove the protective cover from the USB slot.
2. Connect the USB cable to the device.
3. Plug the USB cable into the wall charger or a powered USB port such as a computer that has a charger plugged in.
4. The device lights will turn on and blink according to charge level.

A fully-charged communication device will run for approximately 40 continuous hours.

Battery Tips

The communication device uses an internal, rechargeable Lithium-ion (Li-ion) battery to supply power. While these batteries last for years with minimal decrease in performance, there are a few tips to prolong the life of the battery.

- Avoid full discharges and charge the battery more often between uses.
- Avoid storing the communication device in a high temperature (above 86° F / 30° C) area.

Connecting to a Wireless TROLL Com

A Wireless TROLL Com can be used to connect the instrument to software if the sonde is deployed on a cable.

1. Turn on the Wireless TROLL Com.
2. Make sure the cable is connected to the instrument as well as the communication device.

-
3. Go to Bluetooth settings on your mobile device or computer.
 4. From the Bluetooth section, search for devices.
 5. Tap or click the serial number of the communication device to pair the device with the phone or computer. The serial number is located under the USB flap.

Connecting to VuSitu

1. Open the VuSitu Mobile App. If you have correctly paired your Wireless TROLL Com with your wireless device, and the instrument is available, the software will connect and display readings.



If the Searching screen continues to show, tap "Choose another device" and select the device you are trying to connect to.

Connecting to Win-Situ 5

1. Open Win-Situ 5 Software.
2. When prompted, "Connect to device now?" click **No**.
3. Plug the USB charging cable into the computer and Wireless TROLL Com.
4. Click **Preferences**, then click **Comm Settings**.
5. Select the correct Com port used by the charging cable, then select the communication settings for the instrument you are connecting. The following default communication settings are most common for In-Situ instruments:
 - Baud: 19200
 - Data Bits: 8
 - Parity Bits: Even
 - Stop Bits: 1
 - Device Address: 1
 - Mode: Modbus-RTU

If you cannot connect using these settings, click the "Search for Devices" or "Reset All Devices" button.

6. Click the checkmark, then click the Connect button in the lower right hand corner.

Power Options

Internal Power—Batteries

Internal batteries are not user-replaceable. The approximate percentage of the power remaining in an internal battery is displayed on the Home Screen when an instrument is connected to Win-Situ Software.

The instrument is powered by 3.6 VDC, supplied by a sealed, non-replaceable AA lithium battery. Battery life depends on sampling speed. The battery typically lasts for 10 years or 2,000,000 readings, whichever occurs first.

When an instrument is wired to a data logger or PLC controller, power to the instrument is supplied by the data logger or controller.

AC Adapter

The AC adapter provides 24 VDC, 0.75 A, AC input 100-250 V and includes a North American power cord. The TROLL Com Communication Device includes an external power input port for connection to the AC adapter.

Description	Part Number
AC Adapter 24 VDC	0052440



Use only In-Situ Inc.'s AC adapter. Damage to the instrument caused by the use of third-party converters is not covered by the warranty.

External Power—External Battery Packs

External battery packs can significantly increase the life of an instrument, either for long-term deployments or to preserve an aging instrument.

TROLL Battery Pack

The sealed, submersible TROLL Battery Pack supplements internal battery power when an instrument is used for fast, frequent sampling or during long-term deployments. When this power source is connected, the instrument will use the external battery source first and switch to the internal batteries when external battery power is depleted. Total battery life depends on the sampling speed.



Description	Part Number
TROLL Battery Pack	0051450

The sealed, submersible TROLL Battery Pack supplies 14.4 V. When this power source is connected, the Level TROLL will use the external battery source first and switch to the internal batteries when external battery power is depleted.

0.5 second sampling interval	1.2 months
1 second sampling interval	2.3 months
1 minute (or longer) sampling interval	1 year

TROLL Replaceable Battery Pack

The TROLL Replaceable Battery Pack supplements internal battery power when a Level TROLL or Aqua TROLL 100 or 200 Instrument is used for frequent, fast sampling or during long-term deployments. When this power source is connected, the TROLL instrument will use the external battery source first and switch to the internal batteries when external battery power is depleted. Battery life depends on sampling rate. This battery pack allows for 1.5 V UM-3 or size AA batteries (8) that are replaced by the user.



The TROLL Replaceable Battery Pack is not submersible.



Description	Part Number
TROLL Replaceable Battery Pack	0090000

Estimated Battery Lifetime

<i>TROLL Battery Pack</i>	Level TROLL Family
15 minute logging rate*	1.1 years
1 hour logging rate*	1.1 years

*Logging with all sensors. Actual battery lifetime varies based on site conditions.

<i>TROLL Replaceable Battery Pack</i>	Level TROLL Family
15 minute logging rate*	1.6 years
1 hour logging rate*	1.7 years

*Logging with all sensors. Actual battery lifetime varies based on site conditions.

Installation Accessories

NPT Adapter

The 0.25 in. NPT adapter allows instrument installation in piping.

Part Number	Image	Description
0051470		NPT Adapter

Cable Extender

The cable extender connects two lengths of RuggedCable System to meet varying installation needs.

Description	Image	Part Number
Cable Extender		0051490

Twist-Lock Hanger

The Twist-Lock Hanger is used with a suspension wire to install a non-vented instrument when the user does not require direct communication.

Part Number	Image	Description
0051480		Twist-Lock Hanger, titanium for Level TROLL 400, 700, 700H, BaroTROLL

Bulkhead Connector

The panel-mounted bulkhead connector provides connection between RuggedCable System and a controller panel.

Part Number	Image	Description
0053240		Bulkhead Connector

Locking Well Cap



Description	Part Number
Locking Well Cap, 2"	0020360
Locking Well Cap, 2" vented	0020370
Locking Well Cap, 4"	0020380
Locking Well Cap, 4" vented	0020390

Well Dock Installation Ring

The well dock installation ring provides installation support for 2", 4", and 6" well casings.

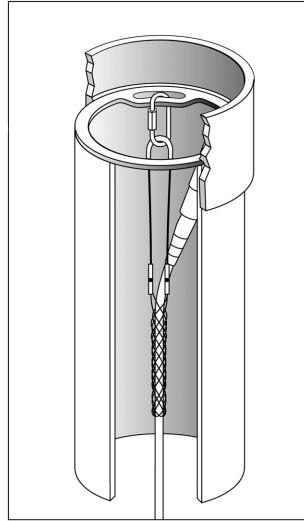

Description	Part Number
Well Dock Installation Ring 2"	0004690
Well Dock Installation Ring 4"	0004700
Well Dock Installation Ring 6"	0020650

Software

TheLevel TROLL can be programmed using the VuSitu Mobile App for Android, or using Win-Situ 5 Software.

About VuSitu

VuSitu is the mobile user interface and control application for In-Situ water quality instruments. You can use VuSitu on mobile devices with Android operating system 4.4, *Bluetooth* 2.0 and newer. Download the latest version of the app from the Google Play Store at play.google.com.

VuSitu allows you to accomplish the following tasks.

- View live readings that update every 10 seconds
- Change parameters and units
- Set up a data log
- Record data
- Email data in spreadsheet format
- Download data to mobile device
- Transfer data from mobile device to a computer
- Organize data by Location
- Calibrate Sensors and View Reports

Connecting Your Instrument to VuSitu

To use VuSitu, you will need a Bluetooth-enabled mobile device, a Wireless TROLL Com and a deployment cable.

Attach one end of the cable to the Wireless TROLL Com and secure the other end to the instrument. Press the power button on the Wireless TROLL Com and open the VuSitu mobile app on your phone or tablet.

VuSitu will automatically search for Bluetooth devices nearby, but you will need to select the correct instrument when connecting for the first time. Select **Choose or Add a Device**. You should see the serial number of the instrument you wish to pair. Tap the serial number to connect. Tap the **Back** button on your device to view the Connected Instrument screen.

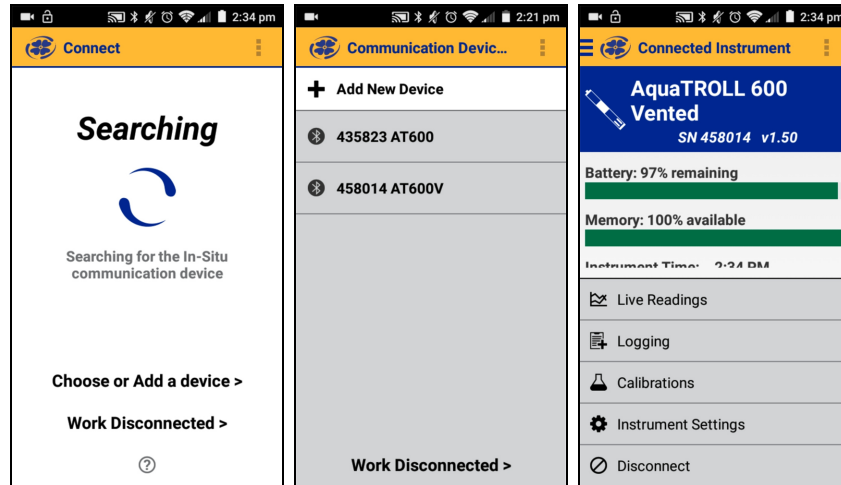

VuSitu Menu Options

The features available in the VuSitu mobile app vary slightly depending on the instrument to which it is connected. Tap the menu icon in the upper left portion of the screen to view the features included in VuSitu. Tap the menu icon again to close the menu.

Menu Options when Connected to Instrument

Some features, such as sensor calibration, are not available when you are not connected to an instrument.

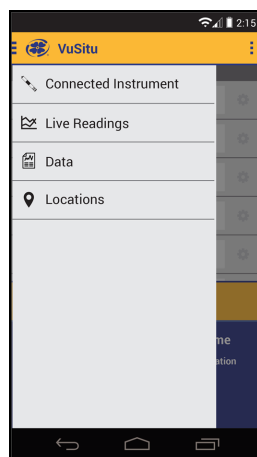

Live Readings Screen

The live readings screen displays instrument readings when the app is connected to the communication device and/or to the instrument via Bluetooth.

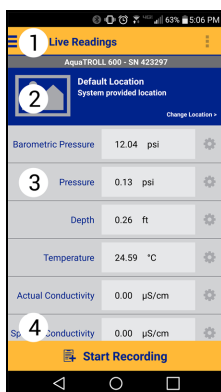

1	Main Menu
2	Selected Location (Tap to change Location.)
3	Live Readings (scrollable) Tap the settings wheel next to each to change parameters and units.
4	Tap to record readings (Readings refresh every 10 seconds.)

Record Data

1. From the Live Readings screen, tap Start Recording. A new set of readings is updated every 10 seconds and a counter of readings is displayed in the Stop button.
2. It is optional to mark a set of readings by tapping the Mark button.



3. When you have gathered enough data, tap the Stop button.
4. The recorded data appears on screen. If you have marked data it will appear as a highlighted row.

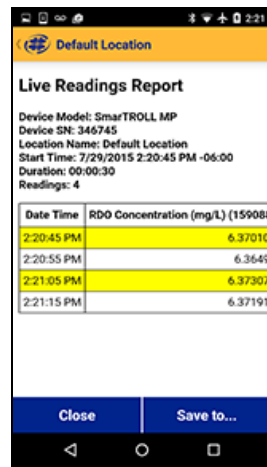

5. If you want to return to the Live Readings screen, tap the Close button. (Your data can be accessed later in the Data section of the app.)
6. If you want to send your data, tap the Send To... button.

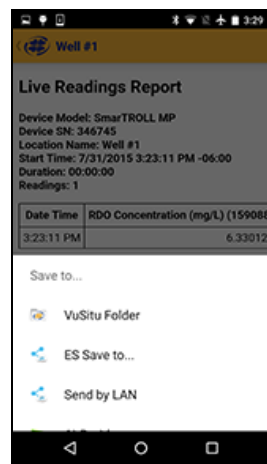

- Select the VuSitu Folder to later download your data to a computer via USB connection.
- or
- Select your email application to email the data.

Changing Parameters and Units

1. From the Live Readings screen, tap the settings wheel next to the field that contains the measurement value. When you release, the Parameter and Unit menu appears.

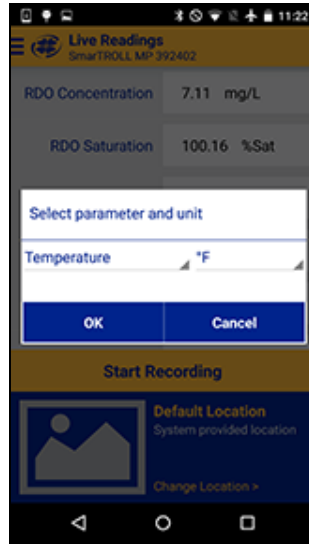

2. Tap the parameter drop-down arrow and tap the parameter you want to display.
3. Tap the units drop-down arrow and tap the unit you want to display.
4. Tap the OK button to set the options and return to the Live Readings screen.

Getting Started

This section provides an overview of the initial steps necessary to prepare the instrument to log data.

- Select the appropriate TROLL Com Communication Device. This determines the hardware connections, and may influence the software installation. The drawing on the following page shows the function of the different TROLL Com Communication Device models.
- Install the software.
- Connect the hardware.
- Open the software and establish communication with the instrument.

Select a TROLL Com Communication Device

The subsequent figure shows the function and connection features of the TROLL Com Communication Device models.

- A Direct-Connect TROLL Com might be preferred for programming an instrument that will be deployed on a suspension cable.
- A RuggedCable System and a Cable-Connect TROLL Com are required if you intend to communicate with the instrument while it is deployed. However, you can program the instrument with any TROLL Com.
- A Wireless TROLL Com will allow you to connect to the VuSitu mobile app, which you can use to configure and deploy your instrument.

RS232

USB

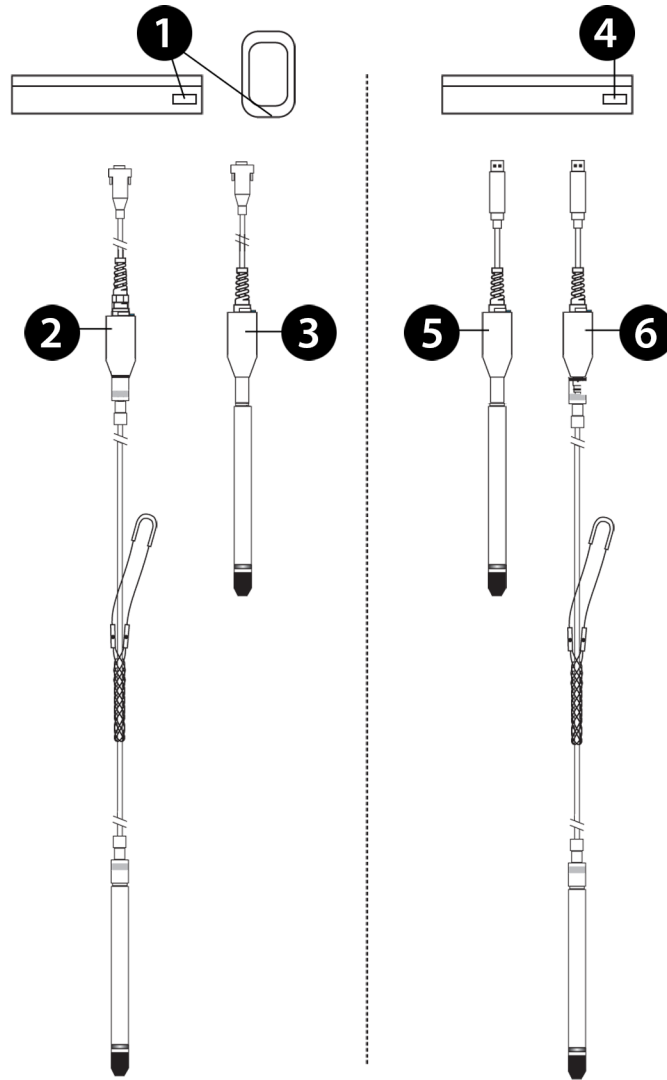

1	Cable-Connect TROLL Com Communication Device, serial connection, for field use
2	Direct-Connect TROLL Com Communication Device, serial connection, programming only, not submersible
3	USB port on a PC/laptop
4	Direct-Connect TROLL Com Communication Device, USB connection, programming only, not submersible
5	Cable-Connect TROLL Com Communication Device, USB connection, for field use

Connecting RuggedCable

Connect the Instrument to the RuggedCable

1. Remove the protective caps from the instrument and cable. Ensure that the O-ring on the instrument connector is clean. Apply a small amount of vacuum grease to the o-ring.
2. Position the instrument and cable flat edges so they will connect properly. Insert the instrument connector firmly into the cable connector.



3. Hold the textured section of the sleeve in one hand and the instrument in the other. Push and twist until you hear a click. The click ensures the cable and instrument are securely attached.



Connect TROLL Com Communication Device to the RuggedCable System

1. If a desiccant is present, remove the desiccant from the cable. Twist the desiccant and cable sleeve in opposite directions to unlock the desiccant from the cable.
2. Position the TROLL Com and cable flat edges so they will connect properly. Push and twist until you hear a click.

Install the Software

Win-Situ 5 Software

Install Win-Situ 5 Software from the In-Situ software/resource CD or from the In-Situ website. Click the Win-Situ 5 link, and follow the instructions to install Win-Situ 5 to your local hard drive.

USB TROLL Com Drivers

If you are using a USB TROLL Com Communication Device, be sure to select the option "Install USB TROLL Com Drivers" during the Win-Situ 5 installation. Two drivers will be loaded to your hard drive, one for the USB TROLL Com, one for the USB TROLL Com serial port.

Field Deployment

Program the Instrument

In order to set up a log or download data, you must connect the instrument to a computer running Win-Situ 5 software or to a mobile device with the VuSitu app. See page 52.

Position the Instrument

Place the instrument at the desired depth. Position the instrument below the lowest anticipated water level, but not so low that the pressure sensor range might be exceeded at the highest anticipated water level. Refer to the tables below to determine usable depth.



A BaroTROLL Instrument can be deployed with a non-vented instrument to compensate level data for changes in atmospheric pressure. Make sure the clocks on both instruments are synchronized, and install the BaroTROLL in a location that will never be submerged in water. See page 41.

Non-Vented Level TROLL Instrument

Range	Effective Range		Usable Depth	
	PSIA	kPA	Meters	Feet
30	15.5	106.9	11	35
100	85.5	589.5	60	197
300	285.5	1968	200	658
500	485.5	3347	341	1120
1000	985.5	6795	693	2273

* Effective range for psia sensors is limited by an estimated 14.5 PSI atmospheric pressure at sea level.

Vented Level TROLL Instrument

Range	Usable Depth		
	kPA	Meters	Feet
5	34.5	3.5	11.5
15	103.4	11	35
30	206.8	21	69
100	689.5	70	231

Range		Usable Depth	
300	2068	210	692
500	3447	351	1153

Verify Instrument Depth

After you have installed the instrument, it is possible to connect the instrument to a computer or mobile device, open the software, and take a reading to verify the installation position. If the reading confirms that the instrument is in the correct position, you can secure it as described below.

During log setup there was an option to "Remind Me Later" for setting a level reference. If you set the log to remind you later, ensure that the instrument is submerged and set the level reference when prompted. See page 55.

Secure the Cable

The RuggedCable System includes a Kellems grip near the up-hole end. You can compress the wire mesh and slide the grip to the desired location on the cable. Pull on the grip to tighten it on the cable.

Use the loop on the Kellems grip to anchor the cable to a convenient stationary object such as the In-Situ well dock installation ring. To install the Kellems grip to the installation ring, insert the loop into the locking clip on the well dock and position the assembly at the top of a well casing.

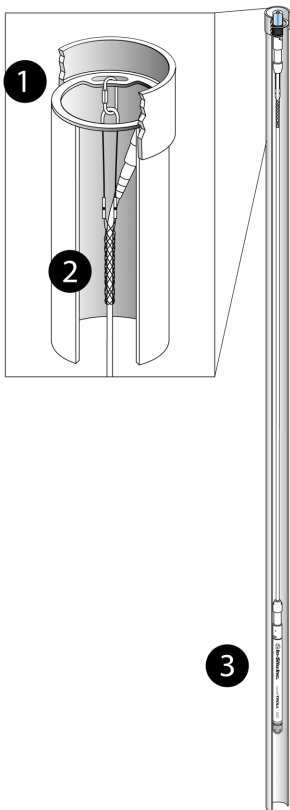

1	Well Dock Installation Ring
2	Kellems Grip
3	Instrument Installed in Well

Install the Desiccant



Vented cable must be protected with a desiccant pack that is properly sized for site conditions.

Desiccant

Desiccant protects cables, connections, and internal components from condensation, which can cause irreparable damage and loss of data. Indicating desiccant changes from blue to pink as it becomes saturated with moisture.

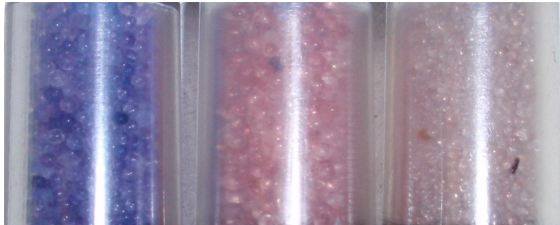

Desiccant stages (from left)

New, nearly expired (replace now), expired

It is **extremely important** to use a properly-sized desiccant for your deployment and to **change desiccant often**. Desiccant should be changed before the entire volume has turned pink, and you should use enough desiccant to effectively keep your equipment dry until your next scheduled maintenance. Desiccant longevity is dependent on site conditions and can vary from one site to the next.

Installation Guidelines

- Never let the instrument fall freely down a well. Doing so will damage the sensor.
- After you have installed the instrument, verify the water level reading. Move the instrument and take another reading to ensure that the instrument shows reasonable change. The instrument could be wedged against the well casing with a loop of cable hanging below. An instrument in such a position could become dislodged and move while it is logging data, which would record a false change in the water level.
- For accurate measurements, the instrument should remain immobile while it is logging data.
- Make sure that the uphole cable end is protected. The vented cable must be protected with a desiccant, and the non-vented cable must be protected with a dust cap. The uphole cable end must be positioned above the highest anticipated water level. Avoid placing this end in a location that might flood.
- Do not deploy instruments in such a way that ice may form on or near the sensor or cable connections. Ice formation is a powerful expansive force that can over-pressurize the sensor or otherwise cause damage. Damage associated with ice formation is not covered by the instrument warranty.
- Do not allow vented cable to bend enough to obstruct the internal vent tube. The recommended bend radius is 13.5 mm (0.54 in), which is twice the cable diameter.

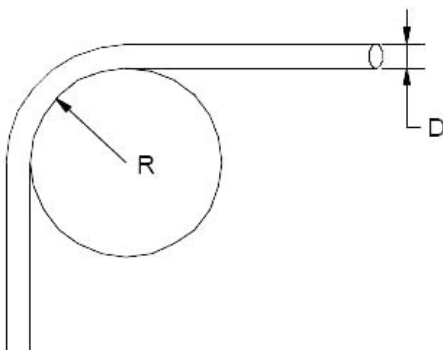

R	Bend radius 13.5 mm (0.54 in)
D	Cable diameter

Stabilization Time

After you have installed the instrument, allow it to stabilize to the environment for about 10 minutes before logging data. The T95 response time for temperature is less than 9 minutes.

A generous stabilization time is always desirable, especially in long-term deployments. Even though the cable is shielded, temperature stabilization, stretching, and relaxing can cause changes to readings.



If you intend to monitor water levels to the instrument's stringent accuracy specifications, allow up to 60 minutes for the probe and cable to stabilize to the environment.

BaroTROLL Instrument Installation

The BaroTROLL Instrument is designed to log barometric pressure from 0 to 16.5 PSIA (1.14 bar, 33.59 inHg) at the surface near a submerged non-vented Level TROLL Instrument or Aqua TROLL 200 Instrument. BaroTROLL data may then be used to correct the water level data for barometric pressure fluctuations. See page 15.



Programming the Baro TROLL Instrument

Connect the BaroTROLL to Win-Situ 5 software or the VuSitu mobile app and sync the clock. See page 53.

Set up a log with the same start time and sample interval as you set up in the non-vented level instrument. See page 54.

Installation

After the BaroTROLL Instrument is programmed, install it in a protected location above the water level near the submerged water level instrument. One installation configuration option is shown below using a twist-lock hanger and a suspension wire.



To prevent flooding of the BaroTROLL electronics, attach the twist-lock hanger before you install the BaroTROLL. Do not submerge the Baro TROLL Instrument.

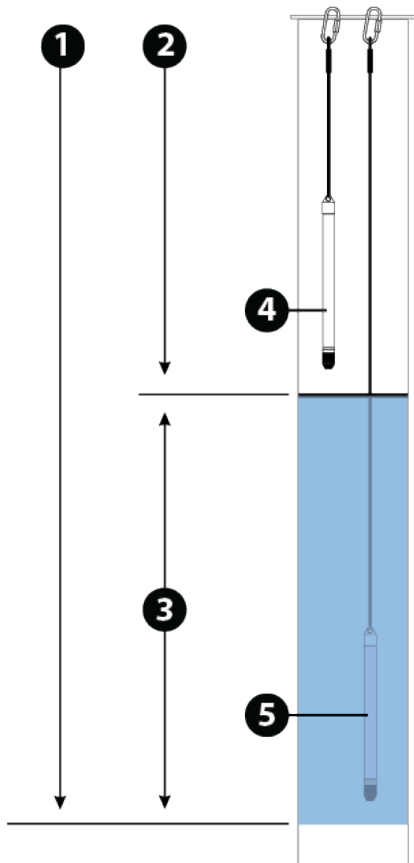

1	Atmospheric pressure + water pressure (as measured by a non-vented pressure sensor)
2	Atmospheric pressure (as measured by the BaroTROLL)
3	Water pressure (as measured by a vented pressure sensor, or by subtracting BaroTROLL data from non-vented pressure sensor data)
4	BaroTROLL Instrument (Do not submerge.)
5	Non-vented Level TROLL Instrument





 To merge atmospheric pressure data with water level data, See page 59.

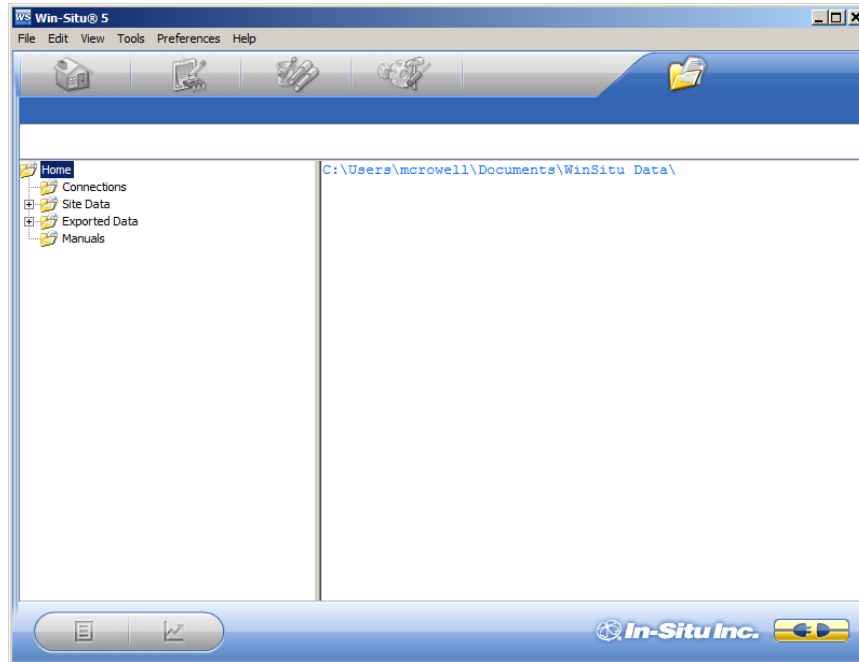

Win-Situ Overview

Data Tab

When you open Win-Situ 5 Software, the **Data** tab appears. The left side of the screen contains a file tree where you can view previously downloaded site data as well as data you have exported to Microsoft Office Excel. The links on the right side of the screen show where downloaded data are stored on your computer. The disconnected plug icon in the lower-right corner of the screen indicates that the software is not yet communicating with an instrument.







Screen Element	Definition
	The disconnected plug indicates the instrument is not communicating with the software. Click to establish communication with a connected instrument.
	The connected plug indicates the instrument is communicating with the software. Click to disconnect the software from the instrument.
	The Home tab displays real-time readings from the instrument. When connection to the instrument is first established, the software displays one reading of all available parameters in light gray. You must click the Play button  at the bottom of the screen to view real-time readings.
	The Logging tab displays a list of logs stored in the connected instrument. When you click the Logging tab, it can take a moment for the software to retrieve information from the instrument. (Not applicable for the RDO PRO-X and the Aqua TROLL 400.)



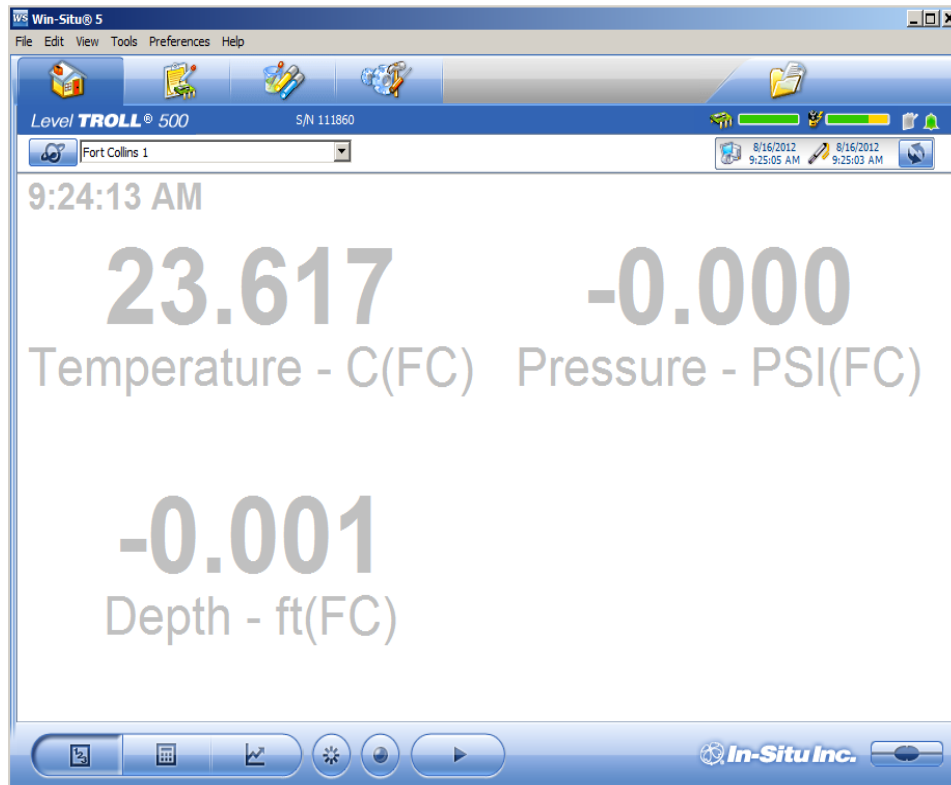



Screen Element	Definition
	The Sensors tab lists the sensors in the connected instrument, along with their serial numbers and the dates of factory calibration and user calibration. Use the buttons in this tab to calibrate sensors that support user calibration and configure sensors that are supported by the instrument.
	The Device Setup tab allows access to instrument information and settings such as instrument name, serial number, firmware version, communication settings, diagnostics, and factory reset options.

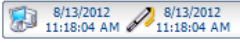

Home Tab

The **Home** tab displays real-time readings from a connected instrument. When you first establish communication, the software displays one reading of all available parameters in light gray.



Screen Element	Definition
	The Sites button allows you to add, edit, or delete a site. Click the drop-down arrow next to the button to view the list of sites.
	The Device Memory gauge turns yellow when the internal memory is used. Note: Non-logging instruments do not have internal memory, however, the gauge shows 100 percent green when power is applied.
	The Device Battery gauge turns yellow as the battery is depleted. This example shows 80 percent of the battery remaining (green) and 20 percent used (yellow). Note: Non-logging instruments do not have internal batteries, however, the gauge shows 100 percent green when power is applied.

Screen Element	Definition
	<p>The Logging Status icon:</p> <p>Green—The instrument is actively logging data.</p> <p>Gray—The instrument has no logs pending or running. Non-logging instruments always show a gray status icon.</p> <p>Yellow—The instrument has log data that was collected according to specific instructions in the "Pending" or "Suspended" state.</p>
	<p>The Alarm icon provides additional instrument status information.</p> <p>Green—No alarms or warnings</p> <p>Yellow—One or more warnings</p> <p>Red—One or more alarms</p> <p>Move the cursor over the alarm icon to view a description. Click the Device Setup tab for detailed information on the alarm or warning.</p> <p>Note: Disregard the Device Reset alarm for non-logging instruments such as the RDO PRO Probe or the Aqua TROLL 400.</p>
	<p>System Time is displayed on the left. Device Time is displayed on the right. Clocks are updated once every two seconds. When the Device Time is displayed in red, it differs from the current System Time, and should be synchronized.</p>
	<p>The Time Sync button is used to write the current PC time to the instrument. If you need to set the instrument clock to a time other than the system (PC) time, use the Set Clock button on the Device Setup tab.</p>
	<p>Meter View shows the last known parameter values, displayed with current units and time stamp. Readings are sized to occupy the entire screen. This is the default display in the Home tab. If the type is black, the readings are updating in real time.</p>
	<p>List View is a running list of the most recent records. New readings are continuously added to the top of the list and old readings scroll off the bottom.</p>
	<p>Graph View shows a real-time trend graph of the selected parameters.</p>

Screen Element	Definition
	The Snapshot button records one set of readings.
	The Record button logs data to a CSV file that can be opened in a spreadsheet program. This is not the same as recording data in a log on the instrument.

Logging Tab

The **Logging** tab displays a list of logs in the instrument. When you click the **Logging** tab, it may take a moment for the software to retrieve information from the instrument.

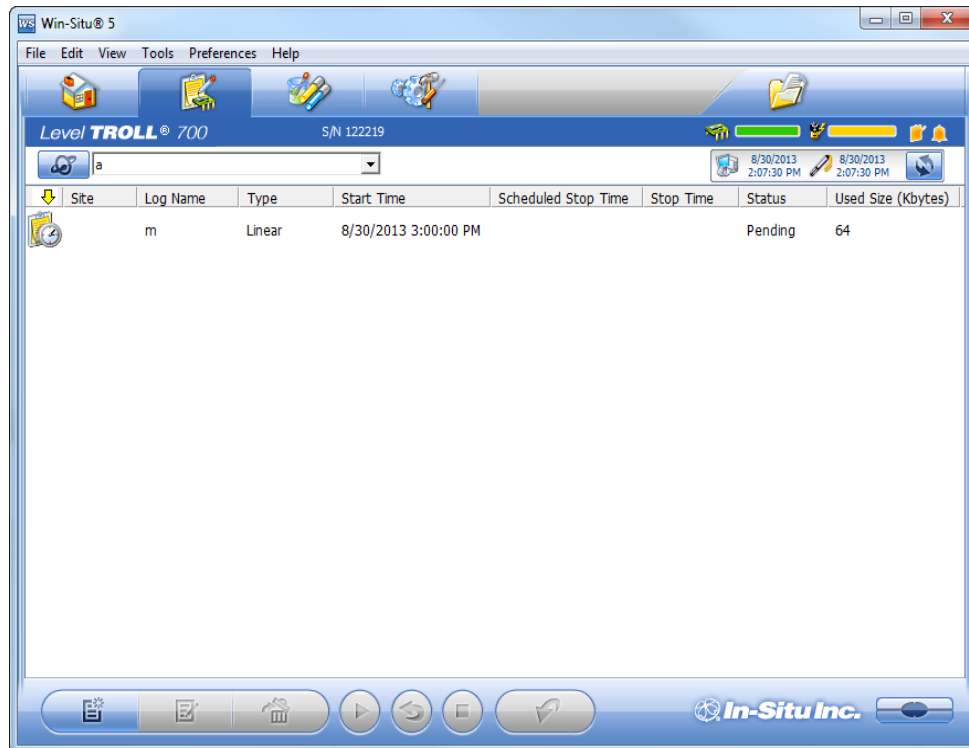

Log Information







Columns across the **Logging** screen show information about the logs in the instrument.

- **Symbol**—This is a graphic representation of the information in the **Status** column.
- **Site**—The site that was specified when the log was configured.
- **Log Name**—The name that was entered when the log was configured.
- **Type**—The logging method that was selected when the log was configured.
- **Start Time**—For a Pending log, the scheduled start time is shown. For a Ready log that has not yet started, this column displays “Manual.” For a Running or Stopped log, the actual start time is shown.
- **Scheduled Stop Time**—For a log with a scheduled stop, the scheduled stop time is shown. For a log without a scheduled stop time, this column is blank.
- **Stop Time**—For a Pending or Ready log, this column is blank. For a Running log, the time of the last data point is shown. For a Stopped log, the actual stop time is shown.
- **Status**—Each log has a specific status. See **Log Status** for details.
- **Used Size**—Kilobytes of instrument memory allocated for this log. For a Pending or Ready log, the current size of the log configuration is shown. For a Completed log, the size of the entire log file is shown. For a Running log, the current size of the log up to the last data point is shown.

Log Status

The status of each log in the instrument is displayed in the Logging tab by a symbol beside the log name, and in the Status column.

 **Ready**—Manual Start log is ready to start.





-
-  **Pending**—Scheduled start log is ready to start at its programmed time, or when you click the **Start** button.
 -  **Running**—The log is actively logging data.
 -  **Suspended**—The log has been paused (stopped temporarily).
 -  **Stopped**—The log has been stopped, either manually or on a schedule.
 -  **Deleted**—The log has been marked for deletion and will be deleted from the instrument when memory is needed. The software manages this automatically.
 -  **Invalid**—The log as programmed cannot be run.



Ready, Pending, Running, and Suspended logs are considered active. Only one log can be active in the instrument.



Log Control Buttons

You can control the status of a log by selecting the log and clicking the appropriate button in the **Logging** tab control panel:

-  The **Start** button starts a **Ready** or **Pending** log, or resumes a **Suspended** log.
-  The **Pause** button pauses a **Running** log allowing you the option to resume it.
-  The **Restart** button restarts the selected **Running** log from the beginning. This can be useful during aquifer testing using a logarithmic data collection schedule.
-  The **Stop** button permanently stops the selected **Running** log.

Log Operations

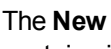
Use the buttons in the control panel to perform the following actions:

-  Create a new log.
The **New** button is disabled if a Ready, Pending, Running, or Suspended log is on the instrument. When the instrument contains its maximum number of logs, the New button is unavailable.
-  **Edit** (or review) the log configuration for a Ready, Pending, or Invalid log.
-  **Delete** the log. (Note that you must delete a log twice before it is permanently removed.)
-  **Download** the log to a PC.

Sensors Tab

The **Sensors** tab lists the sensors in the instrument, along with their serial numbers and calibration dates. Use the buttons in this tab to calibrate and configure sensors.

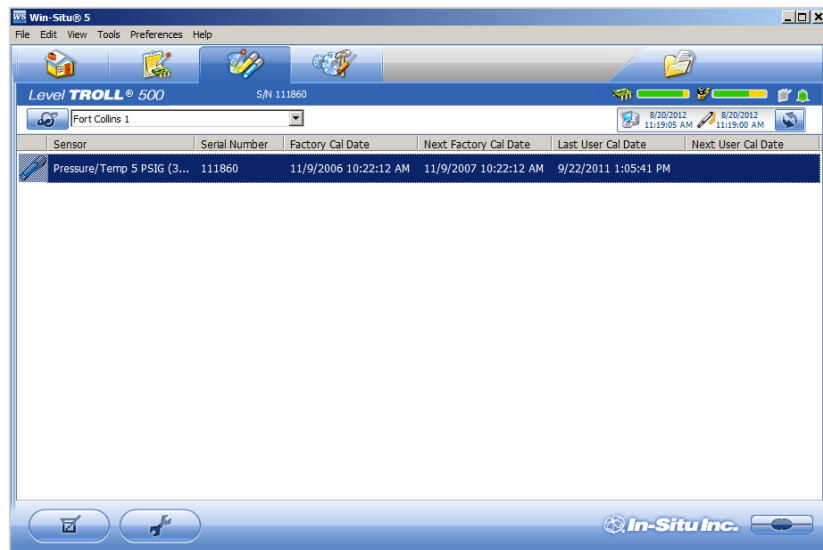

Calibrate

Use the **Calibration** button to calibrate sensors or to adjust a level reference that is currently stored on the instrument. The **Calibrate** button is not available when the instrument does not support calibration (e.g. BaroTROLL Instrument).

1. With the instrument connected to the software, select the **Sensors** tab.
2. Select the parameter you intend to calibrate.

3. Click the **Calibrate** button .

Configure

Use the **Configure** button to select parameter units and to configure parameters that support configuration. Examples include Level/Depth, Specific Conductivity, and Total Dissolved Solids. Parameters cannot be configured while the instrument is showing live data on the **Home** screen or while the instrument contains an active log.

1. With the instrument connected to the software, select the **Sensors** tab.
2. Select the parameter you intend to configure.

3. Click the **Configure** button .



When you configure the Level parameter using the **Sensors** tab, the settings are stored in the instrument and are available for use in Modbus, SDI-12, or analog communication (if available). If desired, a different configuration can be selected when setting up a log.

Device Setup Tab

In general, you should not use the **Device Setup** tab unless you are corresponding with the In-Situ technical support team. However, you can use this screen to set up communication protocols if you are connecting the instrument to a PLC or data logger.

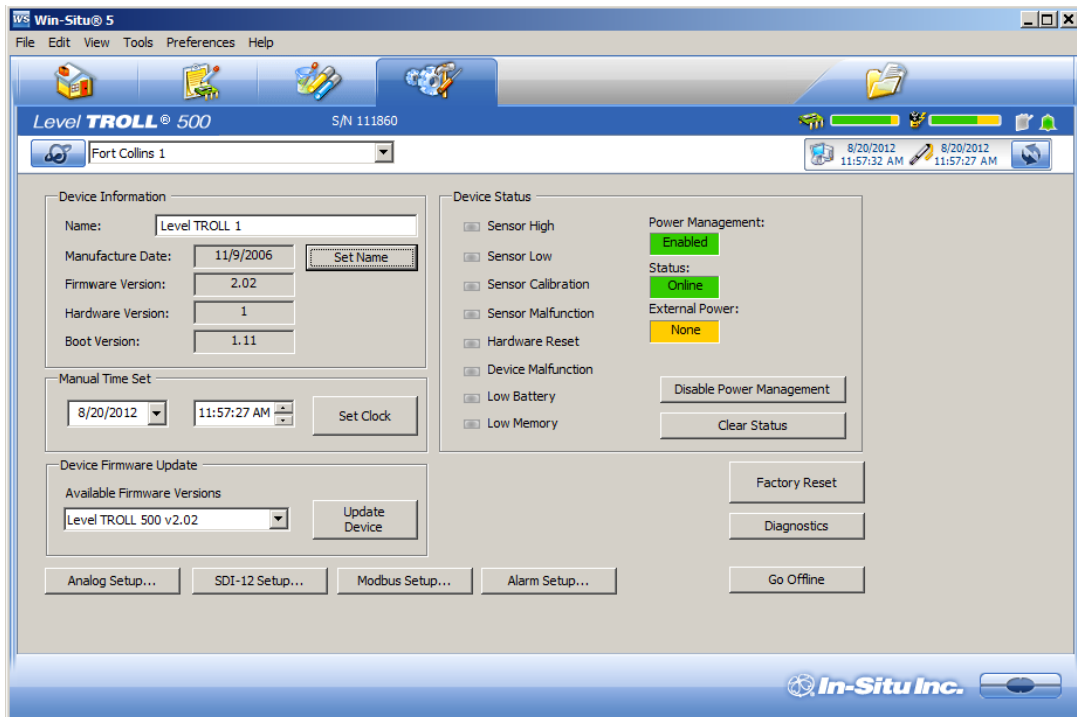

See the online Help for more details.

Using Win-Situ 5 Software

Connecting an Instrument to the Software

When you open Win-Situ 5 Software, you are asked if you want to connect to your device. Click **Yes**. Synchronize the instrument clock to the PC clock. 

The software displays an error message if a connection cannot be established.

Selecting the Correct COM Port

If you are using a USB TROLL Com, select the correct COM port by following the steps below. If you are using a serial TROLL Com, the Win-Situ Software should default to the correct COM port, which is usually COM 1.

Steps for Windows 8.1 and Windows 10 systems.

1. Right-click the **Start** button.
2. Click **Device Manager**.
3. Click the arrow next to **Ports (COM and LPT)**, and locate the USB Serial Port listing. The number listed next to this entry is your COM port address.

Steps for Windows 8 systems.

1. Right-click the **Start** screen.
2. Select **All Apps**.
3. Click **Control Panel**.
4. Open the **Device Manager**.
5. Click the arrow next to **Ports (Com and LPT)**, and locate the USB Serial Port listing. The number listed next to this entry is your COM port address.

Steps for Windows 7 systems.

1. Click the **Start** button, and open the **Control Panel**.
2. Click **Hardware and Sound**, and open the **Device Manager**.
3. Click the arrow next to **Ports (COM and LPT)**, and locate the USB Serial Port listing. The number listed next to this entry is your COM port address.

Steps for Windows XP systems.

1. Click the **Start** button, and open the **Control Panel**.
2. Double-click the **System** icon. Click the **Hardware** tab, and open the **Device Manager**.
3. Click the plus sign next to **Ports (COM and LPT)**, and locate the USB Serial Port listing. The number listed next to this entry is your COM port address.



The following steps apply for all Windows operating systems.

1. Once you have determined the correct COM port address in your operating system, reopen Win-Situ 5 Software.
2. Close any open windows in Win-Situ Software.
3. Click **Preferences**.
4. Click **Comm Settings**, and then click the **Port Number** menu.

5. Scroll down to find the correct COM port address. Click the **check mark** to accept the changes.
6. Click the yellow **Connect** button in the lower right corner to establish a connection to the instrument.

Bluetooth & Wireless TROLL Com

Connect the cable to the Wireless TROLL Com and the Level TROLL instrument. Turn on the Wireless TROLL Com and open Win-Situ 5. Choose **File > Connect** to access the Default Communication Settings window.

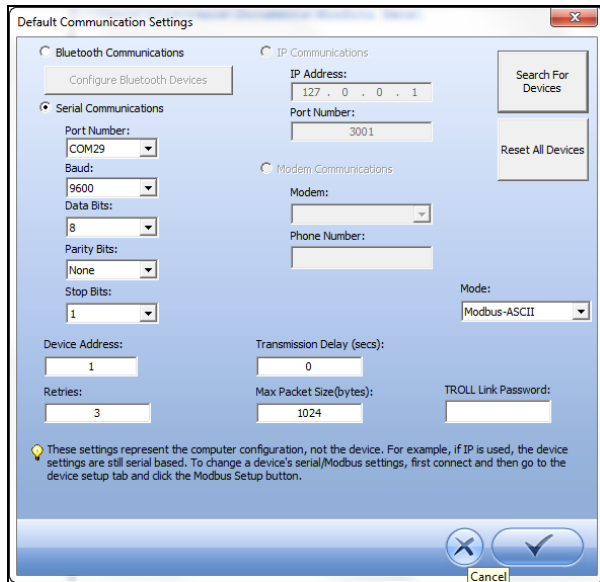

Select the radio button labeled **Bluetooth Communications** and click **Configure Bluetooth Devices**. You will see a list of nearby Bluetooth devices. Click the Wireless TROLL Com you are using and click the check mark.

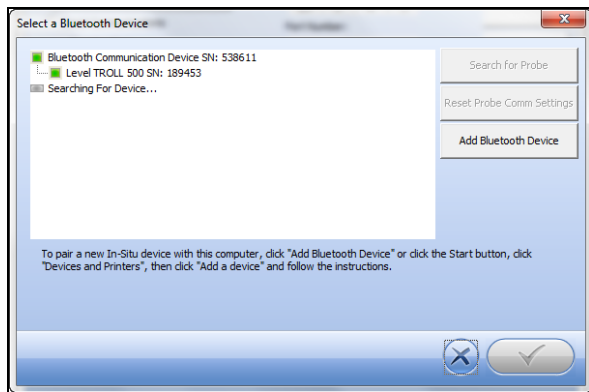

Finally, click the yellow **Connect** button  at the bottom right of the screen to complete the connection.

Setting the Instrument Time

The instrument time and the current PC time are shown at the top of the screen when an instrument is connected to the software.

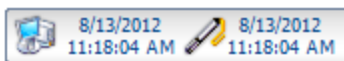

The PC time appears on the left, the instrument time on the right. Both clocks are updated at 0.5 Hz (once every two seconds). The device time is displayed in red if it differs by more than a few seconds from the current PC time. Data logging schedules depend on a correct instrument time.

To synchronize the instrument time to the current PC time, click the **Clock Sync** button . Win-Situ writes the current PC time to the instrument.

Adding a New Site

To add a new site to the site database in your working directory do one of the following:

On the **Data** tab, click the **Site Data** folder, select **File> New > Site**.

or



On the **Home** tab, click the **Site** button to display the site list, then click **New**. Enter a name for the site. This is the only required field.

Click **Save** to save the new site. The new site will appear in the **Site Data** folder, and Win-Situ will add it to the site database in the working directory on your computer. It is now available to select for any instrument log.

Log Setup

The Log Setup Wizard presents sequential screens to help you supply all the information necessary to set up a data log in the instrument.

To access the Log Setup Wizard the instrument must be connected to the software.

1. Click the **Logging** tab .
2. Click the **New** button .



The **New** button may be disabled or may show a warning if an active log already exists on the instrument, or if the instrument is polling live data (see the **Home** screen), or if the device already contains its maximum number of logs.

3. Select the **Site** where the set of data will be logged and supply a name for the log.
4. Click the **right arrow** to continue after each step.
5. Select the parameters you intend to measure, choose the measurement units, and specify the order in which the selected parameters will be logged.
6. Select the logging method you intend to use. See page 54.
7. Select the log interval. A log interval is how often a measurement will be taken and stored.
8. Select the start condition, stop condition, and specify how to handle full device memory.
9. If you selected **Level** or **Depth** as a parameter to measure, specify how you intend to log this parameter. See page 55.
10. The final screen summarizes the log setup. Click the **check mark** to write this information to the instrument.

Logging Method Descriptions

The following is a list of log types and their descriptions. The log types that are available on an instrument vary depending upon the capabilities of the instrument.

Logging Methods for Long-Term Monitoring

Linear

Linear log type measures and records at a user-defined fixed interval of one minute or more. This method is used for long-term studies, landfill monitoring, stream gauging, tidal studies, and background monitoring prior to aquifer testing. Intervals are measured in days, hours, or minutes.

Linear Average

Linear Average log type can smooth out anomalous highs and lows that may occur in a data set, for example, when a water wave passes over the instrument. Each stored measurement is the average of several rapid measurements. This method is used for long-term studies, stream gauging, tidal and open-water studies where trends are more important than accuracy. Intervals are measured in days, hours, minutes, or seconds.

Event

Linear Event log type combines basic fixed-interval logging of specified parameters with the ability to log data at a faster interval when a single-parameter event condition is present.

Logging Methods for Aquifer Testing

True Logarithmic

True Logarithmic log type captures early-time water-level data during aquifer testing. Measurements are very closely spaced at the start of the test (4 measurements per second) and move further apart on a logarithmically decaying schedule as the test progresses. There are 40 measurements per log decade. This log type is commonly used for rapid step-drawdown pump tests, constant-rate pump tests, and slug tests.

Fast Linear

Fast Linear log type measures and records at a user-defined fixed interval of one minute or less. The interval is small (seconds, milliseconds), and the test is usually of short duration due to the volume of data logged and the impact of very fast sampling on battery life.

Step Linear

Step Linear log type measures and records data according to a number of user-defined elapsed time intervals or "steps" within a schedule. Both the elapsed time and the number of measurements within each step can vary. After completing the elapsed time for each step, the schedule will automatically move to the next step. Up to 10 separate steps can be defined.

About the Level Reference

A Level Reference, also called an offset, is a user-specified starting point for logged Level readings. It is entered in the Logging Setup Wizard when a log is configured, or it can be stored in the device without configuring a log using the **Configure** button in the **Sensors** tab.

Depth mode does not require that you enter a Level Reference.

The Level Reference can be any value you choose. Here are some examples:

- **Elevation**—If you calculate the water level above mean sea level (MSL) and enter this as the Level Reference, then elevations above MSL will be logged.
- **Depth to Water**—If you measure the depth to the water surface (DTW) from the top of the well casing and enter this as the Level Reference, then DTW (also called drawdown) values will be logged.
- **Gauge Height or Stage**—Logged readings track water level as related to markings on a nearby staff gauge.
- **Zero**—A Level Reference of 0 effectively sets the probe to zero at the start of the log. Changes, both positive and negative, from the starting water level, will be logged.

Once you have determined the value of your Level Reference, the software gives you three options for entering it. These control when the level reference is applied.

- **New Reference**—This option is designed to be used with an active software connection when the device is installed in the water.



A new level reference must be entered while the device's pressure sensor is submerged in its final position in the water. This is because the current probe reading is set equal to the Level Reference to create the offset that takes effect at the start of the data log. The log header will show the probe reading at the time you entered the Level Reference.

During log setup, the software presents two additional options for entering the Level Reference:

- **Set first logged reading**—Use this option when the instrument will be deployed on wire rather than cable because you will not be able to communicate with the instrument when it is submerged.
- **Remind me to set reference later**—Use this option to defer the entry of the Level Reference during log setup and set a reminder to enter it when the device is submerged in its final position.

Starting a Log

Every log is programmed for either a manual or a scheduled start. A log with a manual start time is displayed in the Logging screen with **Ready** in the **Status** column. A log with a scheduled start time is displayed with **Pending** in the **Status** column.

Starting a Pending Log

A **Pending** log automatically starts at the scheduled time without any user intervention.



A scheduled log with **Pending** status can be manually started at any time before its scheduled start.

Starting a Manual Log



With the instrument connected to the software, select the **Logging** tab.

Select the Ready log you want to start.

Click the **Start Log** button . The log starts and the symbol changes. The **Status** column displays **Running**.

Suspending (Pausing) a Log

A running log may be temporarily paused. For example, you might want to reposition an instrument, calibrate a sensor, or clean a sensor and later resume the log. A log can be suspended and resumed three times.

1. With the instrument connected to the software, select the **Logging** tab .
2. Select the log you intend to suspend.
3. Click the **Suspend** button . **Suspended** appears in the **Status** column.

Resuming a Suspended Log



1. To resume logging after a log has been suspended, select the **Logging** tab.
2. Select the **Suspended** log.
3. Click the **Start Log** button . Logging resumes. **Running** appears in the **Status** column. The data file will show the time when the log was suspended and the time when it restarted.

Stopping a Log

A log can be manually stopped at any time, even if a stop time has been previously scheduled. If you did not specify a stop condition when you defined the log, the log will run until the instrument is out of memory or battery power, or until you manually stop it.





A log that has been stopped cannot be resumed. If you intend to resume a log later, you should suspend a log rather than stop it.

1. To manually stop a log, the instrument must be connected to the software.
2. Select the **Logging** tab .
3. Select the running log you intend to stop.
4. Click the **Stop Log** button .

Downloading Data to a PC

This procedure copies the data log from the instrument to a PC. It does not remove the data log from the instrument. After a log is downloaded, it can be exported to a CSV file format that can be used by spreadsheet programs. The time shown in the log name is the time the log was downloaded.

1. With an instrument connected, select the **Logging** tab .
2. Select the log you intend to download.
3. Choose a Running, Suspended, Stopped, or Deleted log.
4. Click the **Download**  button.
5. In the next screen, select one of the three download options.
 - All data
 - New data (data logged since the last download)
 - Time interval to download



New data is downloaded by default to a new log file. To append new data to the last download of this log, be sure the option "Append logs on download" is selected in the **General Settings** dialog (**Preferences > General Settings**).

2. The log is copied to the connected PC into your Win-Situ working directory folder. View or change the working directory using **File > Settings**.
3. At the end of the download, Win-Situ gives you the option of viewing the data.
 - Select **Yes** and the log is displayed in the **Data** screen.
 - Select **No** and the **Logging** screen appears. You can view the data at any time by selecting it in the **Data** tab.

Viewing Logged Data

1. To view the data stored in the instrument, you must first download the data. A connection to an instrument is not needed after the data log has been downloaded.
2. Select the **Data** tab .
3. On the left side of the screen, select the log you want to view. To expand a folder shown in the navigation tree, double-click the folder. The content of the data log is displayed on the right side of the screen in text or graph format.



To switch between view formats, click the **Text** or the **Graph** button in the control panel. To customize the text or graph view, select **Preferences > Graph Settings** or **Preferences > Data View Settings**. These options apply to all downloaded data until you change the options.

Using BaroMerge Software

BaroMerge Software is used to post-correct absolute (non-vented) level sensor data to eliminate barometric pressure effects from the measurements. BaroMerge Software can be accessed through the Win-Situ 5 Software **Tools** menu. BaroMerge provides three options to correct data.

- **Fixed Correction**—A single offset value is applied to all selected log data. Use this option if you know the barometric pressure of the site during the log, and know that it did not change.
- **Manual Entry**—Specify two or more correction values to apply to the log data. Use this option if you wish to manually enter a data set of barometric pressure values.
- **BaroTROLL log file**—Absolute level sensor data points are individually corrected to reflect barometric pressure changes that were logged by a BaroTROLL instrument during the approximate time period.



BaroMerge Input—BaroTROLL File

Log files that contain absolute data can be barometrically compensated using values logged by the In-Situ Inc. BaroTROLL Instrument. Select this method when you have access to a BaroTROLL log file covering approximately the same time period as the data file you intend to correct.

To use this correction method, you need the name of the BaroTROLL log file and the name(s) of the absolute log file(s) you want to correct.

1. From the **Tools** menu in Win-Situ 5 Software, select **Win-Situ BaroMerge**.



2. Select the "Use a BaroTROLL file:" option.
3. Click the browse button to the right of the file field.
4. Select a BaroTROLL file and click the **check mark**.
5. Values from the BaroTROLL file will be displayed in the next window. You can edit these values if necessary.
6. Click the **right arrow** button.
7. Select the log file(s) you intend to correct and click the **check mark**.
8. Compensated data files can be viewed or exported from the **Data** tab.

BaroMerge Output

Your original log file is not changed. A new, corrected log file with the same name and path is created. The original ".wsl" extension is replaced by "-Baro Merge.wsl".

Disconnecting an Instrument from the Software

Click the plug icon  in the lower-right corner of the screen to disconnect the instrument from the software. Disconnect the instrument from the communication device. Attach a desiccant pack if you are using a vented cable.

Connect to a Data Logger or PLC Controller

The instrument can be connected to a data logger or controller via a stripped-and-tinned RuggedCable System for communication using one of the following protocols.

- Analog (4-20 mA)
- SDI-12
- RS485 Modbus
- RS232 Modbus (with a customer-supplied converter)

Stripped-and-tinned RuggedCable System includes a female connector on one end that connects to the instrument. The uphole end terminates in stripped-and-tinned wires for connection to a PLC controller or data logger.

A shorter length Stripped-and-tinned RuggedCable System with a male connector is available to convert a female to female RuggedCable System to a stripped-and-tinned configuration.

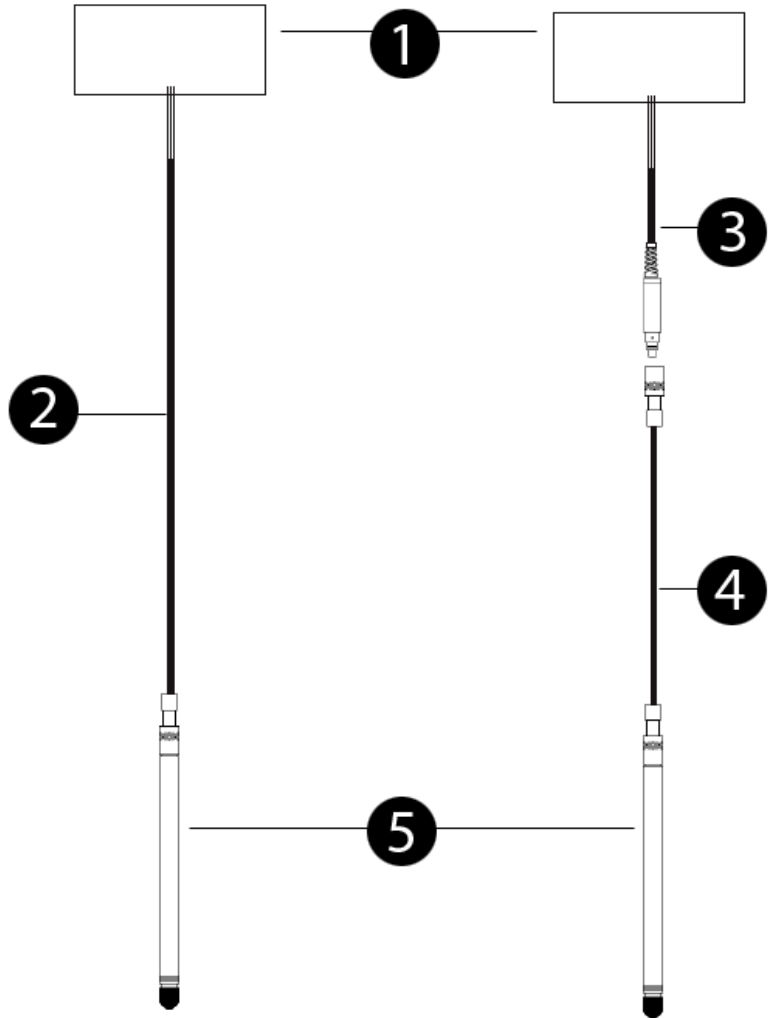

1	PLC or Data Logger
2	Stripped-and-tinned RuggedCable System with female connector
3	Short stripped-and-tinned RuggedCable System with male connector
4	RuggedCable System with female to female twist-lock connector
5	Instrument

Wiring

Refer to the diagrams on the following pages for wiring information. Make sure that you trim and insulate unused wires. The shield must be wired to a chassis ground or earth ground.

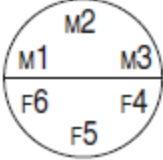
Signal	Color	Pin	
Gnd/Return	Black	6	
Ext Power	Red	5	
4-20 mA	Brown	4	
RS485(-)	Green	3	
RS485(+)	Blue	2	
SDI-12	White	1	

Analog (4-20 mA) 2 Wire

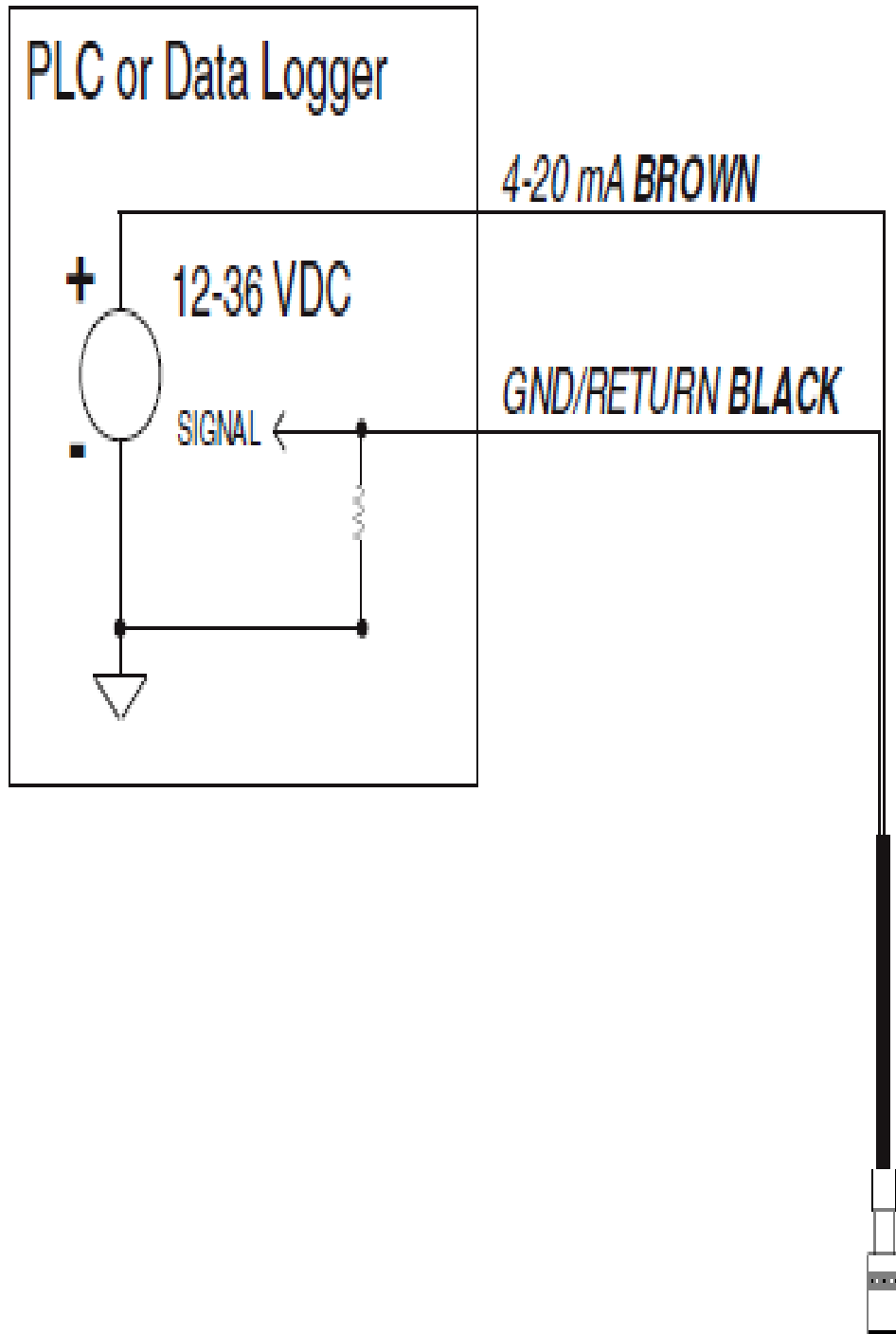

SDI-12 3 Wire

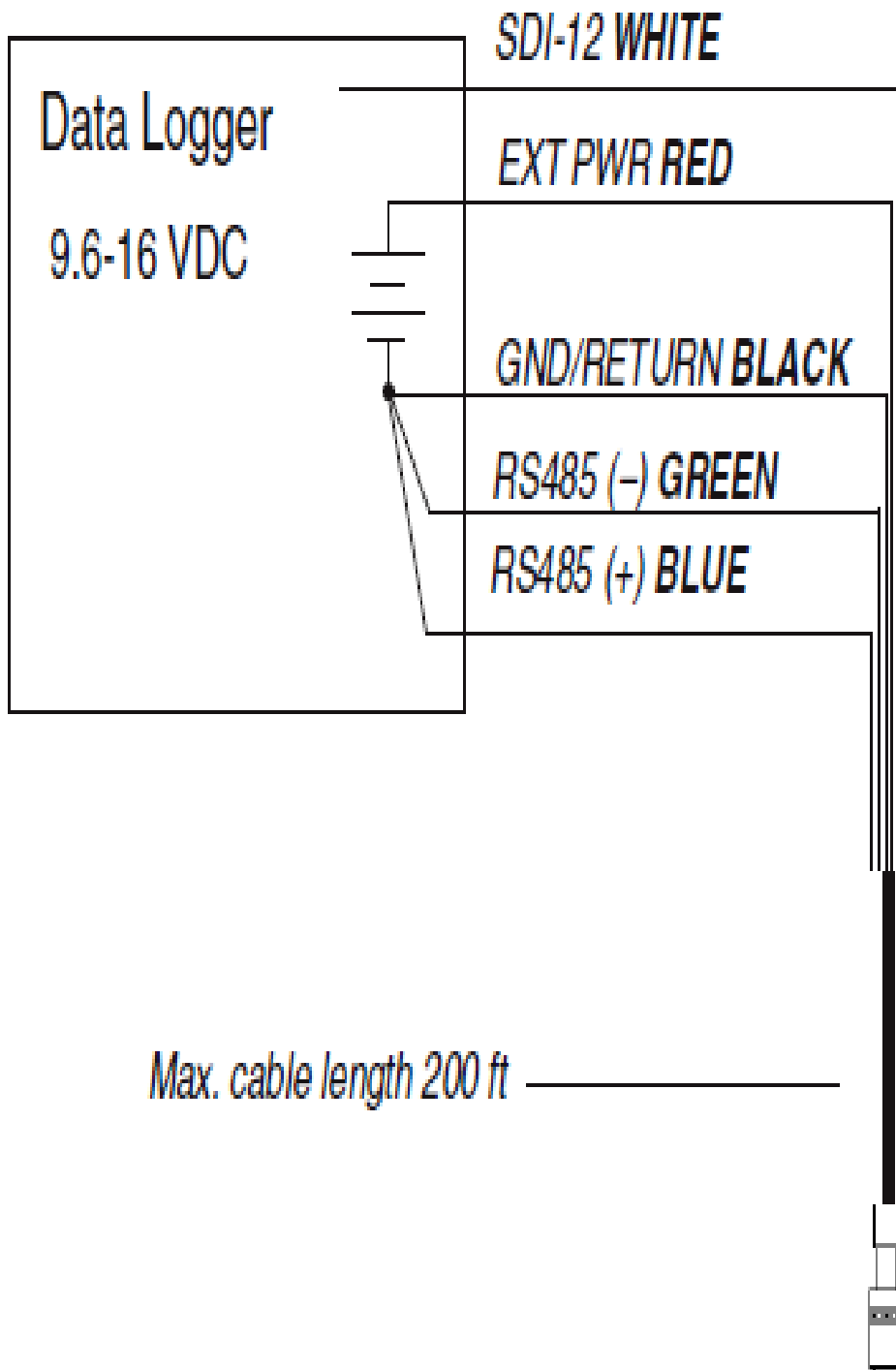

Modbus Master

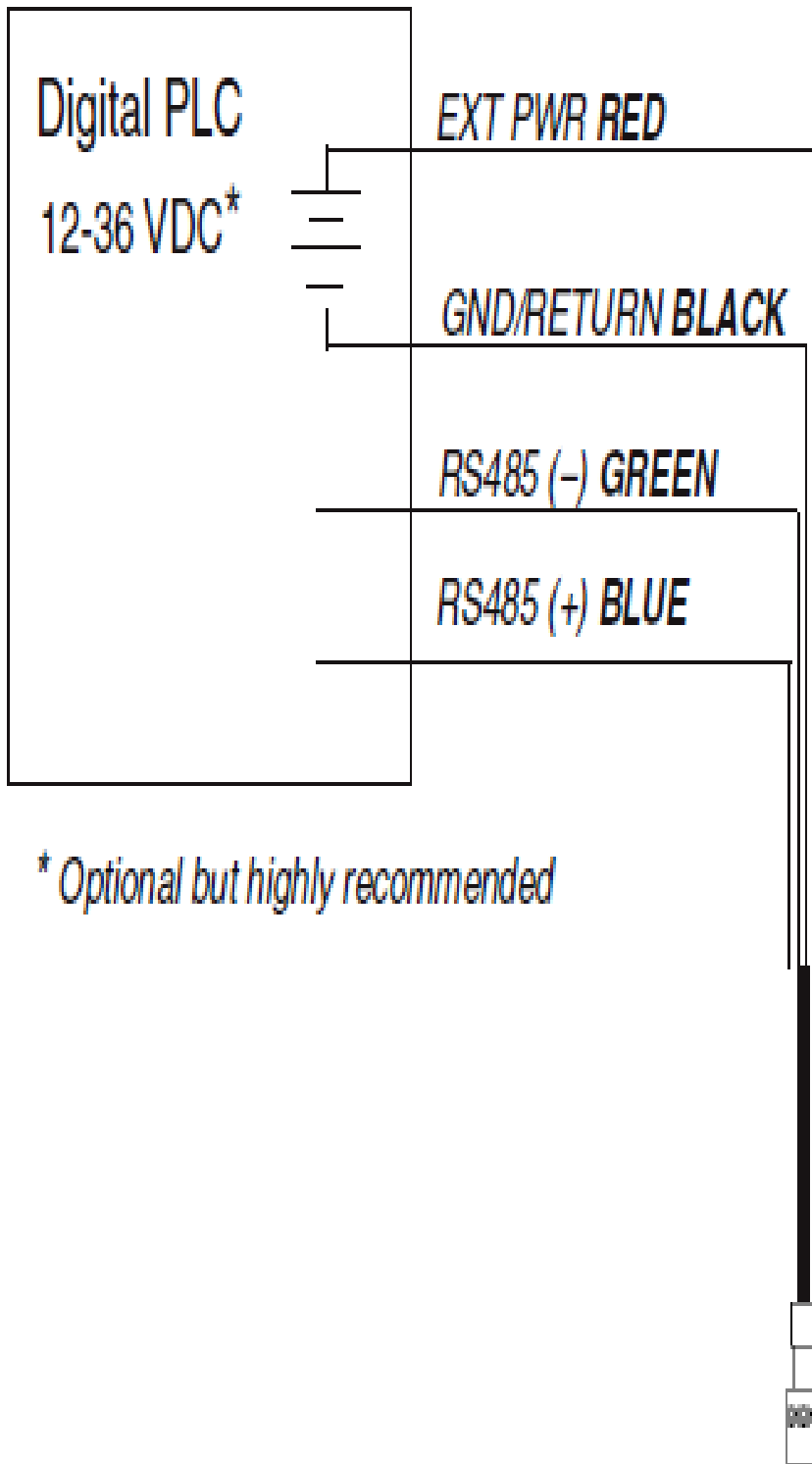

Modbus Master with RS232 (Converter Required)

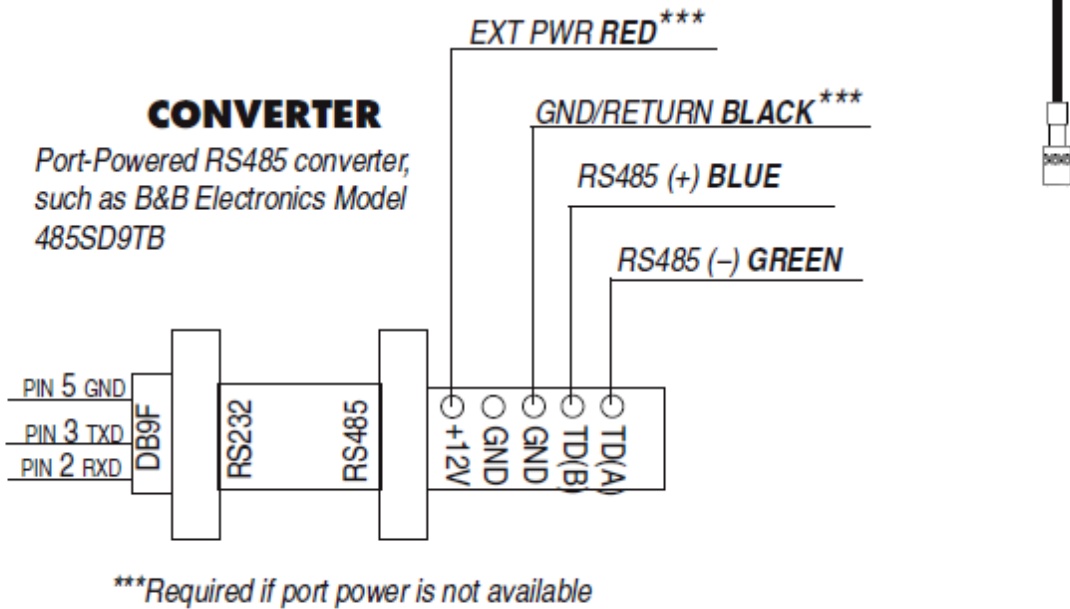
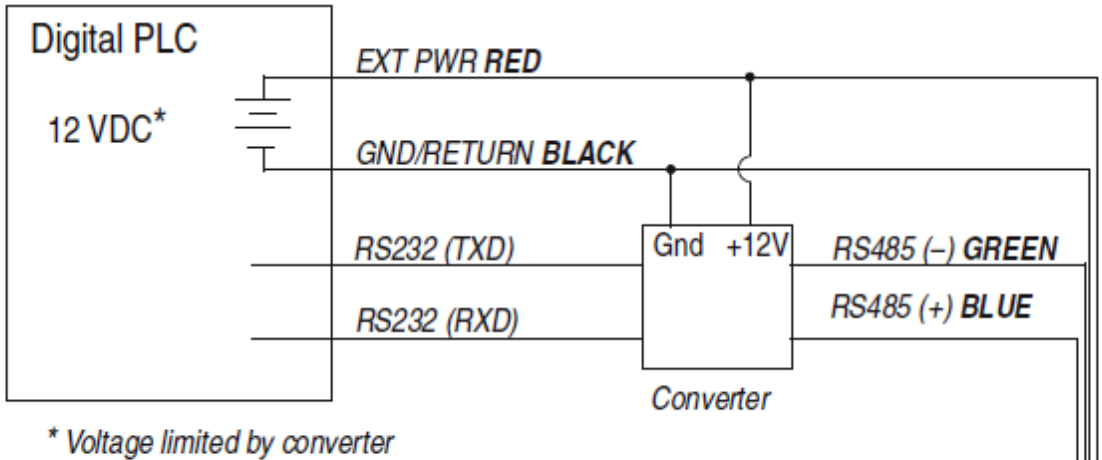

Power Connections

The Red wire provides power for Modbus and SDI-12 modes. The Brown wire provides power for the 4-20 mA mode. If power is present on the Brown wire and not on the Red wire, the device enters the 4-20 mA mode automatically and stays in the 4-20 mode until power is removed from the Brown wire or is applied to the Red wire. The Red wire has priority. If power is applied to the Red and Brown wires at the same time, the device will operate in Modbus or SDI-12 modes but not in 4-20.

Communication Protocols

The device automatically switches between Modbus and SDI-12 modes depending on which of the two interfaces has activity. Modbus and SDI-12 cannot be used at the same time. The communication protocol that is currently in use will block communication on the other.

Win-Situ 5 Software provides options for configuring analog/SDI-12 communications and Modbus communications on the **Tools** tab.

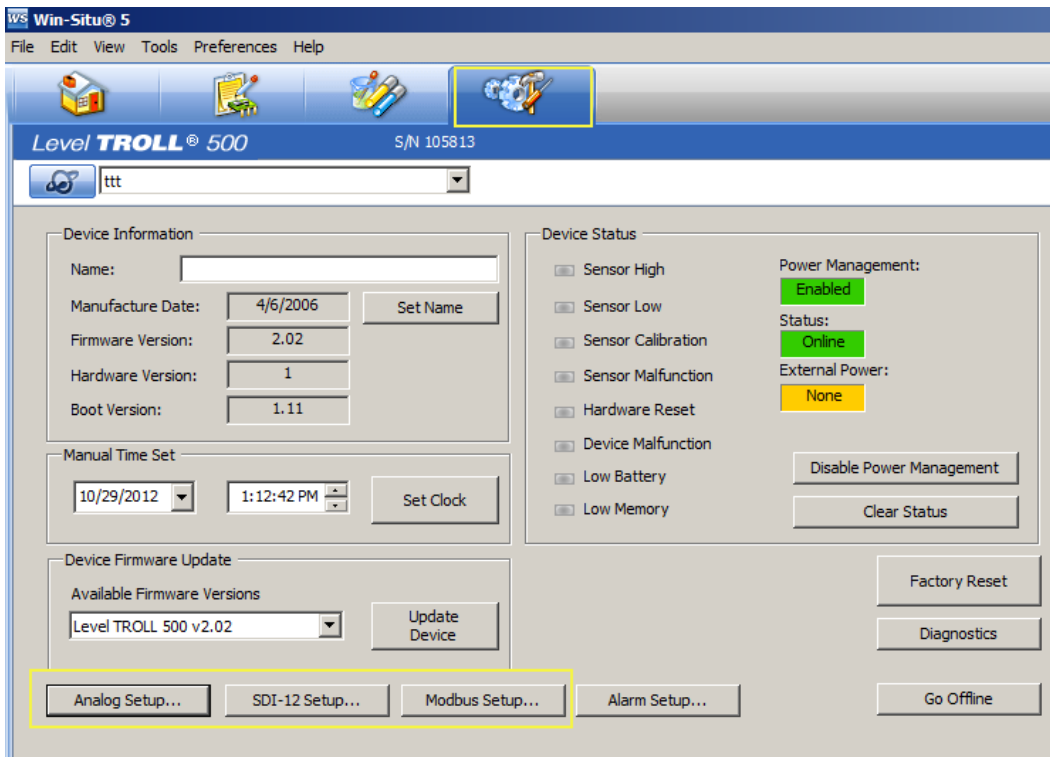

For additional information on Modbus and SDI-12 communications, including the SDI-12 commands and Modbus registers, see www.in-situ.com/Technical_notes and scroll to the Communications and Software Technical Notes section.

Redundant Logging

The instrument is capable of internal logging while participating in a Modbus, SDI-12 or analog network. However, Win-Situ 5 Software cannot communicate with the instrument while it is transmitting Modbus, SDI-12, or 4-20 mA analog data, and the instrument cannot receive or respond to Modbus, SDI-12, or 4-20 mA analog commands while connected to a PC serial port.

If the PLC or data logger loses data, the data that was logged internally on the instrument can be retrieved using Win-Situ 5 Software.

If the PLC or data logger experiences power loss, the instrument will continue to collect data using its internal batteries and clock.

A port-powered RS485 converter like that shown for Modbus connections may be used for temporary connection of the Level TROLL to a serial port on a PC.

Cleaning and Maintenance

Overview

It is important for users to perform scheduled maintenance on their instruments to sustain the accuracy and longevity of the probes and cables. The frequency of this maintenance depends on the characteristics of the deployment site, including humidity levels and the degree of fouling.

Users should be aware of the conditions at their deployment sites and develop appropriate maintenance schedules to replace desiccant, clean the instruments, and send in the instruments for factory calibration. Users should check instruments often during the first portion of the deployment to determine the frequency of maintenance. General maintenance should be performed as often as possible. Factory maintenance and calibration should be performed every 12 to 18 months.

Operating Considerations

The instrument has been designed to withstand harsh field conditions. However, as with any electronic instrument, it can be permanently damaged if used outside its operating specifications.

Temperature

Review the instrument specifications to determine the operating range. Do not deploy instruments in such a way that ice may form on or near the sensors or cable connections. Ice formation is a powerful expansive force that can over-pressurize the sensor or otherwise cause damage that is not covered by the warranty.

Pressure Range

The instrument can withstand pressures of up to two times (2X) the rated range of the pressure sensor without damage, although it may not read correctly at such pressure. If the pressure range is exceeded by 3X, the sensor will be destroyed.

Batteries

Internal batteries in the instrument are not user-replaceable. The approximate percentage remaining is displayed in Win-Situ software or the Vu-Situ mobile app when the instrument is connected.

If batteries are completely exhausted, external power and battery pack options are available. See page 24.

Desiccant Pack Options

Small Desiccant

The Small Desiccant is a disposable cap that ships with In-Situ products. The small desiccant is meant to protect the instrument and cable **only during shipping and should not be used for deployments**.



Large and Extra Large Desiccant

The Large and Extra-Large Desiccant are used to protect equipment deployed in the field. The Large Desiccant is best suited for low-humidity environments or deployments where maintenance occurs regularly. The Extra-Large Desiccant is designed for high-humidity environments or deployments where maintenance occurs infrequently. Extra-Large Desiccants provide six times the drying capability of the Large Desiccant. When the desiccant expires, both can be refilled with fresh desiccant and re-used (see Desiccant Refill Kit below). The Large Desiccant is available with an ABS or a titanium twist-lock connector, while the Extra Large Desiccant uses a titanium connector only.

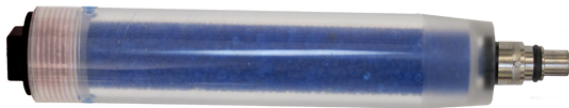

Description	Part Number
Large Desiccant, Titanium	0051810
Large Desiccant, ABS	0053550
Extra Large Desiccant	0090420

Outboard Desiccant

The Outboard Desiccant is a replaceable desiccant pack designed to attach to the vent tube of a stripped-and-tinned cable.

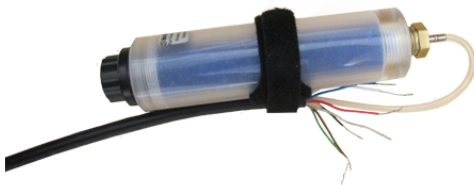

Description	Part Number
Outboard Desiccant	0051380

Desiccant Refill Kit

The Desiccant Refill Kit supplies desiccant for the Large Desiccant, Extra Large Desiccant, and the Outboard Desiccant. It also contains replacement glass wool.

Description	Part Number
Desiccant Refill Kit	0029140

Installing Desiccant with Twist-Lock Connectors

1. Remove the protective dust cap from the bottom of the desiccant pack, if applicable.
2. Remove expiring desiccant (if present) from the cable by grasping the textured section of the cable connector in one hand and the desiccant in the other. Twist in opposite directions to unlock the desiccant from the cable.
3. Attach the new desiccant pack to the twist-lock connector on the cable.



Installing Outboard Desiccant

Vented cable must be installed with outboard desiccant to protect the cable and instrument electronics from condensation in high-humidity environments.

The desiccant can be removed from the vent tube, if necessary, to trim the conductor wires. However, you must reinstall the desiccant after trimming and connecting the wires.

1. Cut off the knot at the bottom of the vent tube extension.
2. Firmly attach the vent tube extension to the cable vent tube. Cover at least 6.4 mm (0.25 in.) of the cable vent tube for a secure attachment.
3. Use the attached hook-and-loop strap to secure the desiccant to the cable, below the stripped wires.

- Remove the red dust cap from the black nylon cap to allow air to reach the cable's vent tube.

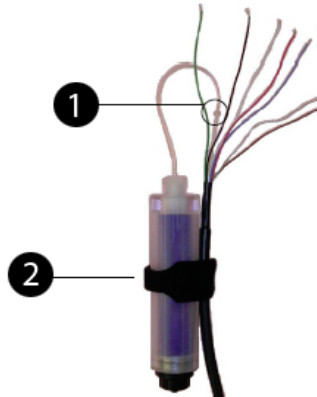

1	Outboard desiccant is attached to the cable vent tube.
2	Desiccant is secured to the cable with a strap.

Using the Desiccant Refill Kit

- Remove the black nylon vent cap from the top of the desiccant.
- Pour out and discard the used desiccant. Check the glass wool in the bottom of the container and replace if necessary.



The glass wool prevents the desiccant beads from falling out the cable end of the desiccant pack. If the wool glass does this effectively, there is no need to replace it when refilling the desiccant.

- Fill the container with fresh desiccant. Replace the vent cap. Reattach to cable if removed.

Antifouling

TROLL Shield Nose Cone

The copper TROLL Shield Nose Cone is designed to reduce macro- and micro-fouling of the pressure sensor on Level TROLL and Aqua TROLL Instruments. Reduced fouling on the sensor improves measurement accuracy and extends the length of deployments.

For optimum performance, the TROLL Shield Nose Cone should be replaced every 12 months or sooner if site conditions are extremely harsh.

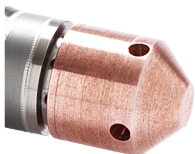

Description	Part Number
TROLL Shield Nose Cone	0081480

O-ring Inspection and Replacement

Examine O-rings for wear, dryness, discoloration, stretching, cracks, nicks, and brittleness. Replace O-rings when any of these conditions are present. Replacing O-rings on an annual basis, regardless of their condition, is the best way to protect against moisture damage.

Perform the following steps to replace an O-ring.

1. Remove and discard the damaged O-ring.
2. Use a clean, dry, soft cloth to clean the O-ring groove to remove dirt or residue.
3. Lubricate the new O-ring using high-vacuum grease.
 - a. Wash your hands thoroughly.
 - b. Apply a small amount of grease to the pad of your index finger, and rub your index finger and thumb together to spread the grease evenly.
 - c. Inspect the new O-ring and remove any debris stuck to it.
 - d. Rub your fingers around the O-ring until there is a thin layer of grease on the entire O-ring.
4. Install the O-ring in the groove and remove any excess lubricant with a clean cloth.

Do not allow water or lubricant to enter the connector.

Cleaning and Storage

Cleaning the Instrument

Clean the instrument body with water and a soft brush or plastic scouring pad, or soak overnight in a mild acidic solution, such as household vinegar. **NEVER** submerge the connector portion of the instrument when it is not connected to a cable.

If the ports near the pressure sensor are clogged with silt or mud, try the following procedures.

- Agitate the instrument vigorously in a bucket of clean water.
- Apply a gentle rinse of water from a wash bottle.
- In severe cases, remove the nose cone and clean out the holes with a soft brush or pipe cleaner.

Do not attempt to remove material from the instrument by tapping the instrument against a surface. To avoid damage to the pressure sensor diaphragm, do not insert any object into the sensor opening or attempt to dig out dirt or other materials. **You void the instrument's warranty by inserting anything into the sensor opening.** If contamination cannot be removed using the recommendations above, please contact In-Situ for cleaning.

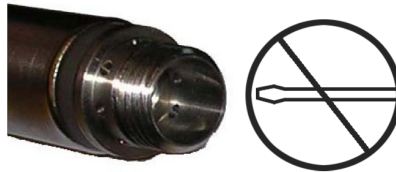

*A TROLL pressure sensor with the nose cone removed. Do not insert **ANY** object into the sensor opening. Doing so voids the warranty.*

Twist-Lock Connectors

Keep the pins on all connectors free of dirt and moisture by using the soft protective dust caps when cable is not attached.

Storage

Store the instrument in a clean, dry place. Place the protective red dust cap on the cable end or store with cable attached to protect the connector pins and O-ring. For vented cables, ensure the desiccant used is the appropriate size and change it when needed. Store the instrument where it will not roll off a bench onto a hard surface or sustain other mechanical shock. Protect the instrument from temperature extremes using the following guidelines:

- Level TROLL Instruments—store within the temperature range -40°C to $+80^{\circ}\text{C}$ (-40°F to $+176^{\circ}\text{F}$)

Factory Calibration and Service

In-House Factory Calibration

Factory calibration of In-Situ instruments should be performed every 12 to 18 months, or at any point when the data appears to drift significantly. Factory calibration includes a thorough cleaning, all operational checks, necessary firmware upgrades, O-ring replacement, and full range calibrations of the pressure sensor, temperature sensor, and conductivity sensor (when applicable).

Return Materials Authorization (RMA) Form

To obtain a factory calibration, fill out and return the online Return Materials Authorization (RMA) form located at www.in-situ.com/.

Obtaining Repair Service

If you suspect your system is malfunctioning and repair is needed, you can help assure efficient servicing by following these guidelines:

1. Call or email In-Situ Technical Support. Have the product model and serial number available.
2. Be prepared to describe the problem, including how the product was used and the conditions noted at the time of the malfunction.
3. If Technical Support determines that service is needed, they will ask your company to fill out the RMA form and pre-approve a specified monetary amount for repair charges. When the form and pre-approval is received, Technical Support will assign an RMA (Return Material Authorization) number.
4. Clean the product as described in the manual.
5. If the product contains a removable battery, remove and retain it unless you are returning the system for a refund or Technical Support states otherwise.
6. Carefully pack your product in its original shipping box, if possible.
7. Mark the RMA number clearly on the outside of the box.
8. Send the package, shipping prepaid, to:

In-Situ
ATTN: Repairs
221 East Lincoln Avenue
Fort Collins, CO 80524

The warranty does not cover damage during transit. In-Situ recommends insurance for all shipments. Warranty repairs will be shipped back prepaid.

Outside the U.S.

Contact your international In-Situ distributor for repair and service information.

Guidelines for Cleaning Returned Equipment

Please help us protect the health and safety of our employees by cleaning and decontaminating equipment that has been subjected to potential biological or health hazards, and labeling such equipment. Unfortunately, we cannot service your equipment without such notification. Please complete and sign the form on page 78 (or a similar statement certifying that the equipment has been cleaned and decontaminated) and send it to us with each instrument.

- We recommend the glassware cleaning product, Alconox, available from In-Situ and from laboratory supply companies.
- Clean all cables and remove all foreign matter.
- Clean the cable connectors with a clean, dry cloth. Do not submerge the connectors.
- Clean the instrument including the nosecone, cable head, and protective caps.



If an instrument is returned to our Service Center for repair or recalibration without a statement that it has been cleaned and decontaminated, or if it is the opinion of our Service Representatives that the equipment presents a potential health or biological hazard, we reserve the right to withhold service until proper certification is obtained.

Decontamination and Cleaning Form

Decontamination & Cleaning Statement

Company Name _____ Phone _____

Address _____

City _____ State _____ Zip _____

Instrument Type _____ Serial Number _____

Contaminant(s) (if known) _____

Decontamination procedure(s) used _____

Cleaning verified by _____ Title _____

Date _____



Troubleshooting

In addition to the following troubleshooting items, the In-Situ website includes instructional videos, technical notes, and more. See www.in-situ.com/.

Problem	Possible Cause	Possible Solution
Win-Situ 5 Software cannot connect to the instrument.	Wrong COM port is selected, communication settings are incompatible, cable connections are loose or dirty, or batteries are low.	<p>Make sure cable connections are tight and connectors are clean and dry.</p> <p>Make sure the cable is securely attached to the instrument.</p> <p>Make sure the correct COM port is selected (select Preferences > Comm Settings to verify).</p> <p>Make sure the communication settings in Win-Situ and in the instrument match. To reset the device communication settings to the serial defaults, click "Reset all Devices" in the Comm Settings dialog (Preferences > Comm Settings).</p> <p>Make sure the internal battery has voltage remaining, or external power is supplied.</p> <p>See www.in-situ.com/Technical_notes and scroll to the Communications and Software Technical Notes section for more information.</p>
Real-time readings display the wrong units.	Default units are being used.	Click the Sensors tab, select the sensor, click the configure button and select the desired units for each parameter in the Sensor Setup window.
Cannot add a new log.	<p>Only one active log can reside in the device at a time—an active log is a log that is Ready, Pending, Running, or Suspended as shown in the Status column of the Logging Tab.</p> <p>The device has its maximum number of logs already stored—the Level TROLL 300, 500, and Baro TROLL have a capacity of 2 logs.</p>	<p>Stop or delete the log if possible. Alternatively, configure the new log after the active log is completed.</p> <p>Download, and then delete a log you no longer need. This will make room for an additional log on the device.</p>
New log exceeds available memory (software message).	The log as configured would exceed the device memory.	<p>Edit the log and select a longer sampling interval.</p> <p>If available, select the "wrap data" option. This causes more recent data to overwrite older data when memory is full.</p> <p>For a log with a scheduled start, select None as the stop condition, or select a stop time that is closer to the start time.</p>

Problem	Possible Cause	Possible Solution
<p>Cannot configure level or other parameters using the Configure button on the Sensors tab. The Sensor Setup screen is shown, but the Configure... button is dim.</p>	<p>The instrument is actively polling (continually updating real-time readings) in the Home tab.</p> <p>The instrument has an active log—a log that is Ready, Pending, Running, or Suspended as shown in the Status column of the Logging tab. Only one active log can reside in the device at a time.</p>	<p>Return to the Home tab and stop real-time readings by clicking the Play button.</p> <p>Stop or delete the log if possible. Alternatively, configure parameters after the log is complete.</p>

Declarations of Conformity and Similarity

Level TROLL 400 Instrument

EMC Verification Declaration of Similarity

Equipment

Type of equipment: Measurement instrumentation
Product name: Level TROLL® 400
Model: Level TROLL® 400

Manufacturer: In-Situ, Inc.
221 East Lincoln Avenue
Fort Collins, CO 80524
USA

Category

Standards

Emission: EN 61326 & FCC Part 15, Subpart B

Immunity: EN61326

Summary

We confirm that the equipment referenced above, without reasonable doubt, will fulfill the requirements concerning electromagnetic compatibility according to the above mentioned standards harmonized with the EMC Directive 89/336/EEC. The Level TROLL 700 was tested and found to be in compliance in the month of January 2006.

Date of Issue: August 30, 2013



Ben Kimbell
Vice President of Research and Development

Level TROLL 500 Instrument

Declaration of Conformity

Manufacturer: In-Situ, Inc.
221 East Lincoln Avenue
Fort Collins, CO 80524
USA

Declares that the following product:

Product name: Level TROLL
Model: Level TROLL 500
Product Description: The Level TROLL measures and logs level and temperature in natural groundwater and surface water.

is in compliance with the following Directives:

89/336/EEC for Electromagnetic Compatibility (EMC) Directive
73/23/EEC for Safety Directive

and meets or exceeds the following international requirements and compliance standards:

- **Immunity**
EN 61326:1997, Electric Equipment for Measurement, Control and Laboratory Use
- **Emissions**
Class A requirements of EN 61326:1997, Electric Equipment for Measurement, Control and Laboratory Use

Supplementary Information:

The device complies with the requirements of the EU Directives 89/336/EEC and 73/23/EEC, and the CE mark is affixed accordingly.



Todd Campbell
New Product Development Program Manager
In-Situ, Inc.
January 17, 2006



Level TROLL 700 Instrument

Declaration of Conformity

Manufacturer: In-Situ, Inc.
221 East Lincoln Avenue
Fort Collins, CO 80524
USA

Declares that the following product:

Product name: Level TROLL
Model: Level TROLL 700
Product Description: The Level TROLL measures and logs level and temperature in natural groundwater and surface water.

is in compliance with the following Directives:

89/336/EEC for Electromagnetic Compatibility (EMC) Directive
73/23/EEC for Safety Directive

and meets or exceeds the following international requirements and compliance standards:

- **Immunity**
EN 61326:1997, Electric Equipment for Measurement, Control and Laboratory Use
- **Emissions**
Class A requirements of EN 61326:1997, Electric Equipment for Measurement, Control and Laboratory Use

Supplementary Information:

The device complies with the requirements of the EU Directives 89/336/EEC and 73/23/EEC, and the CE mark is affixed accordingly.



Todd Campbell
New Product Development Program Manager
In-Situ, Inc.
January 17, 2006



TROLL Com Communication Device

Declaration of Conformity

Manufacturer: In-Situ, Inc.
221 East Lincoln Avenue
Fort Collins, CO 80524
USA

Declares that the following product:

Product name: TROLL Com
Model: USB TROLL Com
Product Description: RS485 to USB converter

is in compliance with the following Directive

89/336/EEC for Electromagnetic Compatibility (EMC) Directive
73/23/EEC for Safety Directive

and meets or exceeds the following international requirements and compliance standards:

- **Immunity**
EN 61326, Electrical Equipment for Measurement, Control and Laboratory Use, Industrial Location
- **Emissions**
Class A requirements of EN 61326, Electrical Equipment for Measurement, Control and Laboratory Use

Supplementary Information:

The device complies with the requirements of the EU Directives 89/336/EEC and 73/23/EEC, and the CE mark is affixed accordingly.



Todd Campbell
New Product Development Program Manager
In-Situ, Inc.
June 17, 2006



Declaration of Conformity

Manufacturer: In-Situ, Inc.
221 East Lincoln Avenue
Fort Collins, CO 80524
USA

Declares that the following product:

Product name: Level TROLL
Product name: Baro TROLL
Product Description: The Baro TROLL measures and logs barometric pressure and temperature.

is in compliance with the following Directives:

89/336/EEC for Electromagnetic Compatibility (EMC) Directive
73/23/EEC for Safety Directive

and meets or exceeds the following international requirements and compliance standards:

- **Immunity**
EN 61326:1997, Electric Equipment for Measurement, Control and Laboratory Use
- **Emissions**
Class A requirements of EN 61326:1997, Electric Equipment for Measurement, Control and Laboratory Use

Supplementary Information:

The device complies with the requirements of the EU Directives 89/336/EEC and 73/23/EEC, and the CE mark is affixed accordingly.



Todd Campbell
New Product Development Program Manager
In-Situ, Inc.
January 17, 2006

